

mhtendustri.com

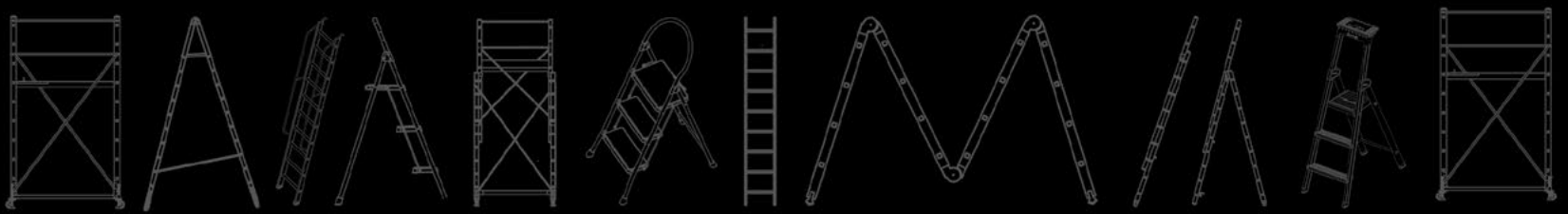

MERDİVEN
ADINA HERSEY
everything about the ladder

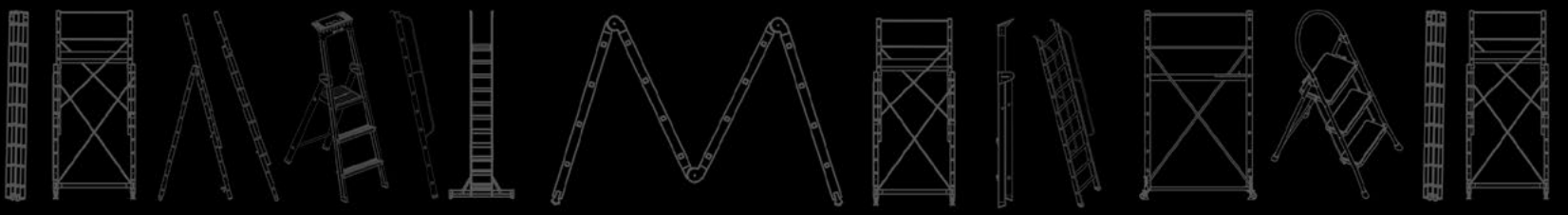
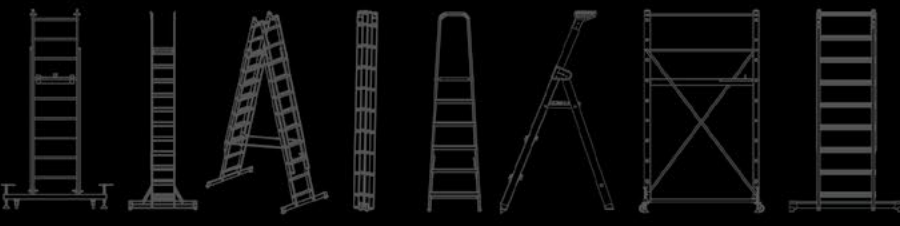
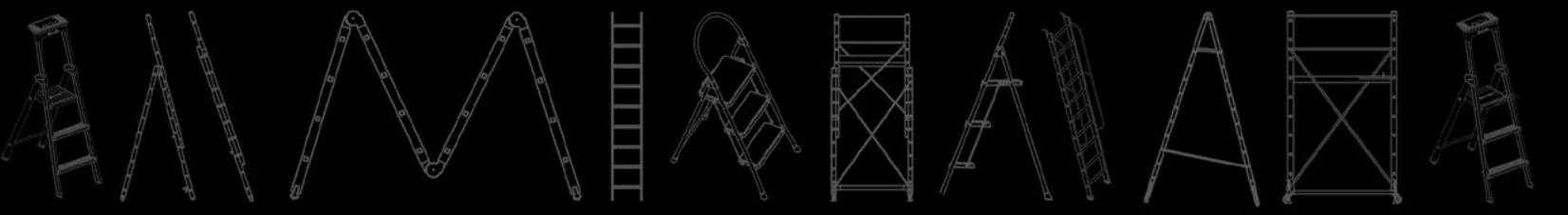
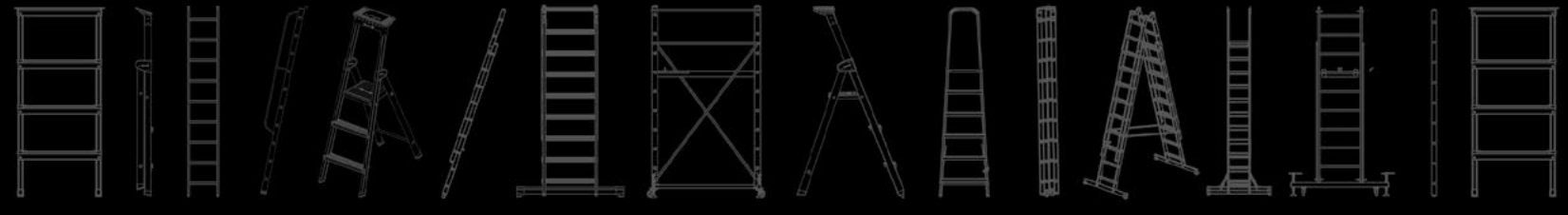
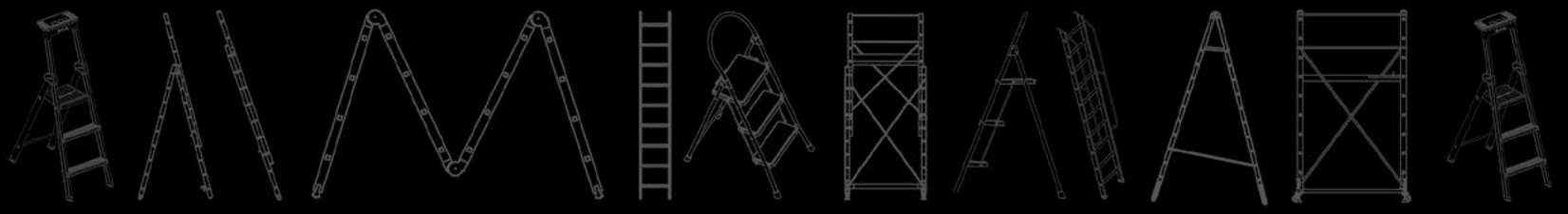

mhtendustri.com

 MHT
ENDÜSTRİ
METAL

MHT ENDÜSTRİ METAL

hakkımızda

2016 yılında Skyline Merdiven ve Alia Ütü Masası ve Kurutmalık markaları ile ticari hayatına başlayan MHT Endüstri, 2019 yılında yaptığı yeni yatırımlarla Alüminyum merdivenlerin üretimine de başlamıştır.

Kalite ve müşteri memnuniyeti odaklı ticari anlayışını, Ar-Ge çalışmaları ve müşteri beklentileriyle bütünleştirerek büyük bir titizlik ve özveri ile üretimine de yansıtılmaktadır.

Endüstriye Merdivenler, iskele sistemleri, Profil merdivenler ve Ev tipi merdivenlerin imalatı ve satışı ile birlikte ütü masası ve kurutmalıkların toptan satışını da gerçekleştirmektedir.

about us

Mht Industri, started its industrial life with Skyline Ladder and Alia Ironing Board and Dryer brand in 2016, began to manufacture aluminum ladder with the new investments made in 2019.

The company combines Research and Development studies and customer expectations with its quality and customer satisfaction oriented trade understanding. It also reflects this understanding to its production.

Skyline Ladder manufactures and sells wholesale industrial ladder, scaffolding systems, profile ladder and household type ladder in addition to this sells in wholesale ironing board and dryer

**merdiven
lerimizi
keşfedin**
explore our ladders



merdiven adına herşey

everything about the ladder



mhtendustri.com

ENDÜSTRİYEL MERDİVEN



ENDÜSTRİYEL
MERDİVEN GRUBU
INDUSTRIAL LADDER GROUP

WWW.
mhtendustri
.com 



Zor koşulları kolaylaştırır.
Makes difficult conditions ease



 Detail / Detail



WWW.
mhtendustri
.com 

Teknik Özellikler - Technical Specification

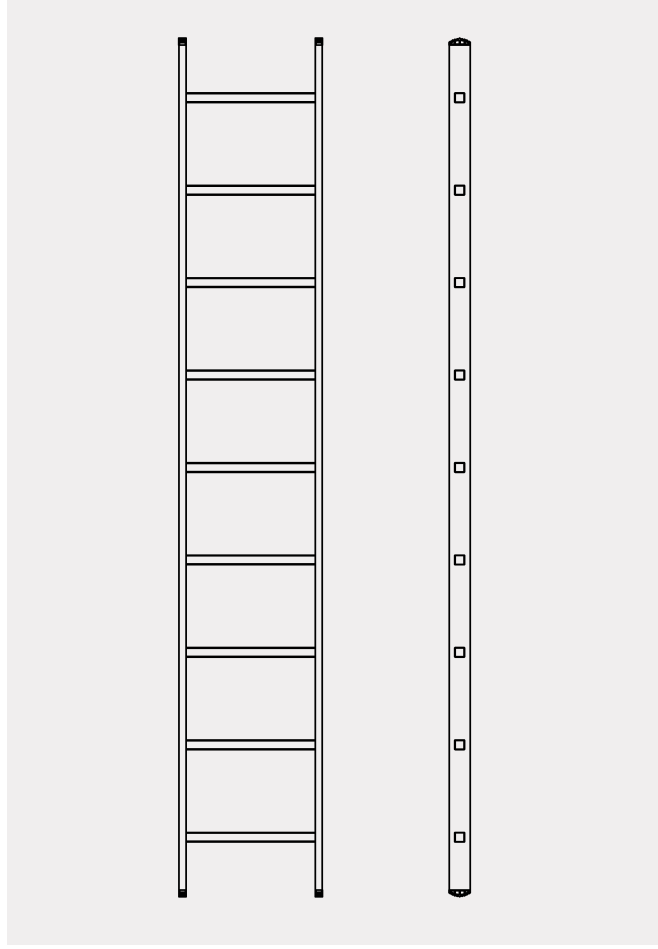

ÖZELLİKLER

- Özel alaşımli alüminyum merdiven
- Kullanıma hazır tek şıklı ambalaj
- Kaymayı önleyen özel tasarımı basamaklar.
- Endüstriyel amaçlı kullanım
- Uzun ömürlü Paslanmaz maksimum mukavemet

SPECIFICATIONS

- Special alloy aluminum ladder
- Single stylish packaging ready to use
- Specially designed anti-slip steps
- Industrial use
- Long lasting stainless maximum strength



SKY BEST TEK PARÇALI Alüminyum Merdiven

ONE SECTIONAL
INDUSTRIAL LADDER

BARKOD BARCODE	KOD CODE	BASAMAK SAYISI NUMBER OF STEPS	PROFİL PROFILE	1.KADEME YÜKSEKLİK FIRST STAGE HEIGHT	ÇALIŞMA YÜKSEKLİĞİ WORKING HEIGHT	DIŞTAN DIŞA GENİŞLİK OUT-TO-OUT WIDHT	AMBALAJ [A,B,C] PACKING DIMENSION	AĞIRLIK WEIGHT
8682538140759	MHT 620	6	63X24	190	305	43	44X9X190	3,9
8682538140766	MHT 625	8	63X24	246	350	43	44X9X246	5
8682538140773	MHT 630	10	63X24	302	410	43	44X9X302	6
8682538140780	MHT 835	12	80X25	358	465	43	44X9X358	7,7
8682538140797	MHT 840	14	80X25	414	515	43	44X9X414	8,9
8682538140803	MHT 845	15	80X25	442	542	43	44X9X442	9,4
8682538140810	MHT 850	17	80X25	498	595	43	44X9X498	10,6
8682538140827	MHT 855	19	80X25	554	648	43	44X9X554	11,8
8682538140865	MHT 860	21	80X25	600	691	43	44X9X600	12,9



Zor koşulları kolaylaştırır.
Makes difficult conditions ease

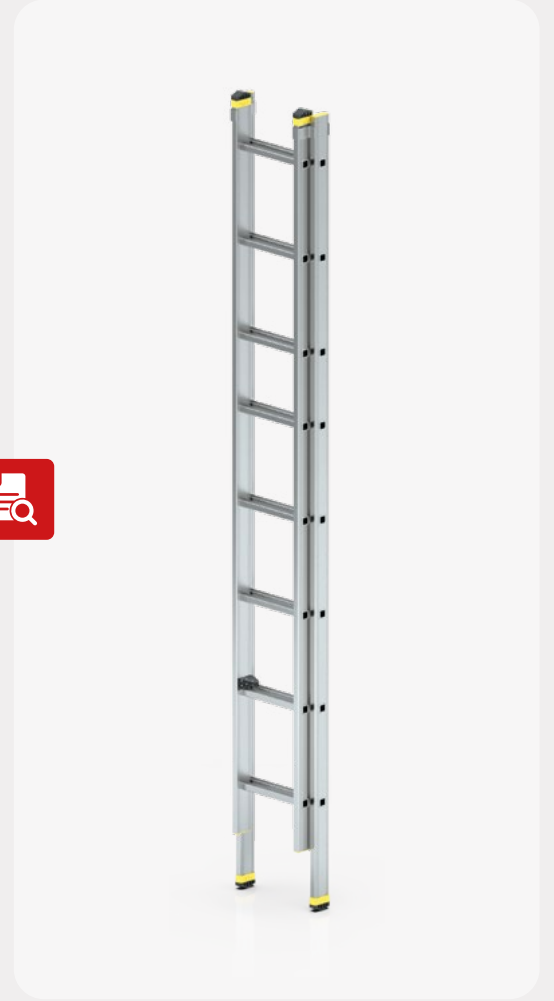

 Detail / Detail



WWW.
mhtendustri
.com 

Teknik Özellikler - Technical Specification

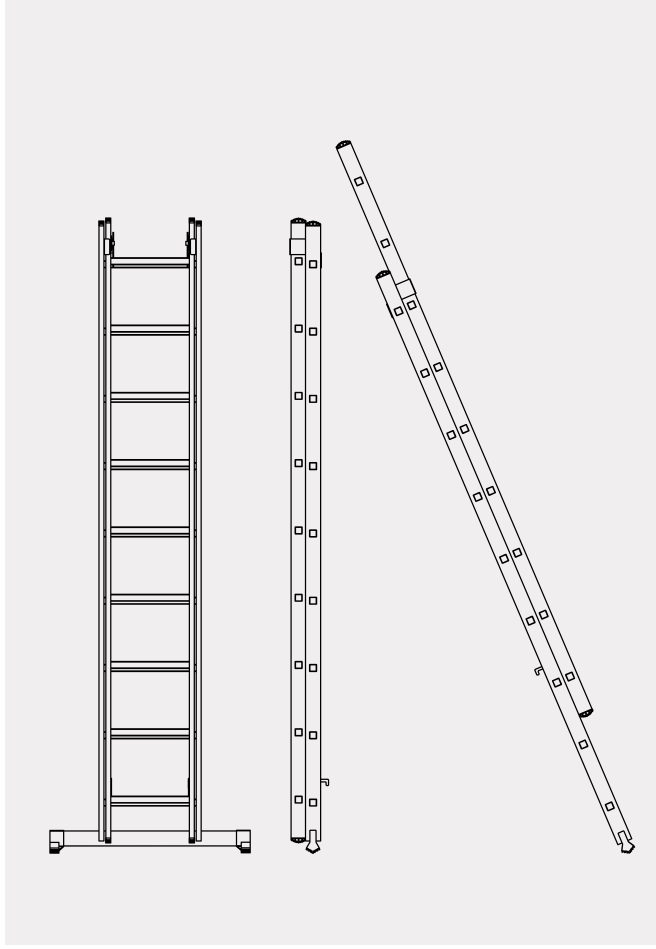

ÖZELLİKLER

- Özel alaşımlı alüminyum merdiven
- 3 kademeli kullanım
- Kolay açılıp kapanabilme
- Tek parçalı kullanım
- Kullanıma hazır tek şıklı ambalaj
- Kaymayı önleyen özel tasarımı basamaklar
- Endüstriyel amaçlı kullanım
- Uzun ömürlü Paslanmaz maksimum mukavemet
- Basamakların maksimum mukavemetini ve dengesini sağlamak için profil bağlantı noktasında çift taraflı şişirme

SPECIFICATIONS

- Special alloyed aluminum ladder
- 3 Sectional usage
- Can be used as single section
- Practical folding away
- Ready to use stylish single pack
- Exclusively designed steps which prevents slipping
- Can be used for Industrial Purpose
- Durable, rustproof, maximum strenght
- Double sided inflating at profile point to provide the maximum strenght and balance of the steps



SKY BEST İKİ PARÇALI Alüminyum Merdiven Sürgülü

2 SECTIONAL
INDUSTRIAL LADDER
(SLIDING TYPE)

BARKOD BARCODE	KOD CODE	BASAMAK SAYISI NUMBER OF STEPS	PROFİL PROFILE	1.KADEME YÜKSEKLİK FIRST STAGE HEIGHT	2.KADEME YÜKSEKLİK FIRST STAGE HEIGHT	ÇALIŞMA YÜKSEKLİĞİ 1 WORKING HEIGHT	ÇALIŞMA YÜKSEKLİĞİ 2 WORKING HEIGHT	DİŞAN DİŞA GENİŞLİK OUT-TO-OUT WIDHT	AMBALAJ (A,B,C) PACKING DIMENSION	AĞIRLIK WEIGHT
8682538140872	MHT S620	2X6	63X24	190	289	305	454	43	44X15X190	8
8682538140889	MHT S625	2X8	63X24	246	380	350	545	43	44X15X246	10
8682538140896	MHT S630	2X10	63X24	302	458	410	623	43	44X15X302	11,9
8682538140902	MHT S835	2X12	80X25	358	537	465	702	43	44X15X358	13,7
8682538140919	MHT S840	2X14	80X25	414	642	515	807	43	44X15X414	15,7
8682538140926	MHT S845	2X15	80X25	442	695	542	860	43	44X15X442	17,8
8682538140933	MHT S850	2X17	80X25	498	774	595	939	43	44X15X498	19,75
8682538140940	MHT S855	2X19	80X25	554	880	648	1045	43	44X15X554	21,45
8682538141930	MHT S860	2X21	80X25	600	984	691	1149	43	44X15X600	23,6



Zor koşulları kolaylaştırır.
Makes difficult conditions ease



Detail / Detail

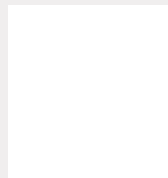
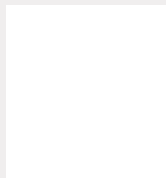
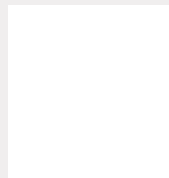

WWW.
mhtendustri
.com

Teknik Özellikler - Technical Specification

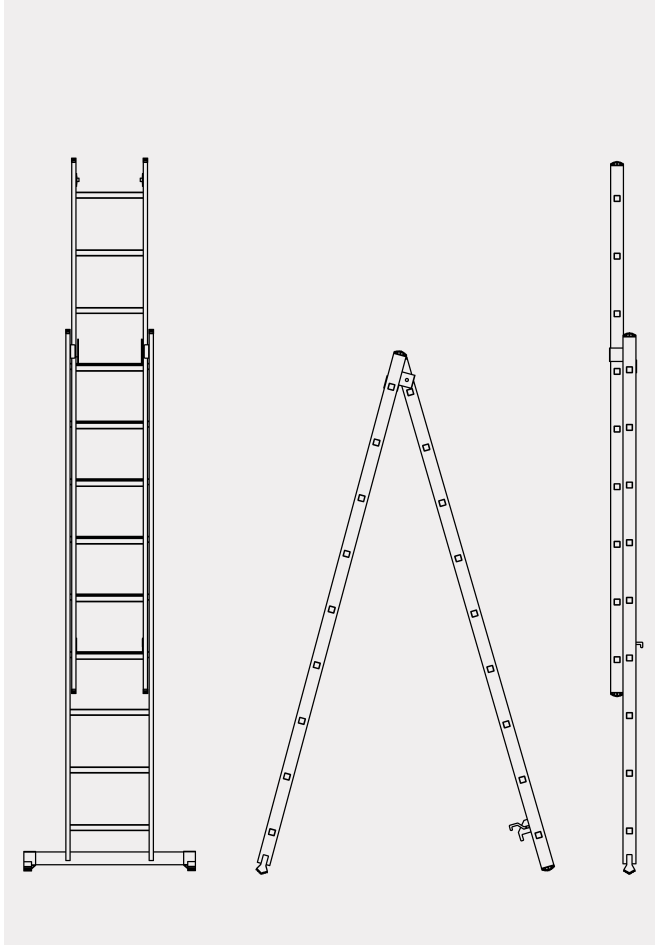

ÖZELLİKLER

- Özel alaşımli alüminyum merdiven
- 3 kademeli kullanım
- Kolay açılıp kapanabilme
- Tek parçalı kullanım
- Kullanıma hazır tek şıklı ambalaj
- Kaymayı önleyen özel tasarımı basamaklar
- Endüstriyel amaçlı kullanım
- Uzun ömürlü Paslanmaz maksimum mukavemet
- Basamakların maksimum mukavemetini ve dengesini sağlamak için profil bağlantı noktasında çift taraflı şişirme

SPECIFICATIONS

- Special alloyed aluminum ladder
- 3 Sectional usage
- Can be used as single section
- Pratical folding away
- Ready to use stylish single pack
- Exclusively designed steps which prevents slipping
- Can be used for Industrial Purpose
- Durable, rustproof, maximum strenght
- Double sided inflating at profile point to provide the maximum strenght and balance of the steps



SKY BEST İKİ PARÇA A Tipi Sürgülü Alüminyum Merdiven

2 SECTIONAL
INDUSTRIAL LADDER
(TYPE A)

BARKOD BARCODE	KOD CODE	BASAMAK SAYISI NUMBER OF STEPS	PROFİL PROFILE	1.KADEME YÜKSEKLİK FIRST STAGE HEIGHT	2.KADEME YÜKSEKLİK FIRST STAGE HEIGHT	3.KADEME YÜKSEKLİK FIRST STAGE HEIGHT	ÇALIŞMA YÜKSEKLİĞİ 1 WORKING HEIGHT 1	ÇALIŞMA YÜKSEKLİĞİ 2 WORKING HEIGHT 2	ÇALIŞMA YÜKSEKLİĞİ 3 WORKING HEIGHT 3	DIŞAN DIŞA GENİŞLİK OUT-TO-OUT WIDHT	AMBALAJ (A.B.C) PACKING DIMENSION	AĞIRLIK WEIGHT
8682538140995	MHT SA64	2X6	63x24	190	182	289	305	454	540	43	44X15X190	8,8
8682538141008	MHT SA65	2X8	63x24	246	234	380	350	545	590	43	44X15X246	10,9
8682538141015	MHT SA66	2X10	63x24	302	286	458	410	623	640	43	44X15X302	13,1
8682538141022	MHT SA87	2X12	80X25	358	338	537	465	702	690	43	44X15X358	15,2
8682538141039	MHT SA88	2X14	80X25	414	390	642	515	807	740	43	44X15X414	17,4
8682538141046	MHT SA89	2X15	80X25	442	416	695	542	860	790	43	44X15X442	19,7
8682538141053	MHT SA810	2X17	80X25	498	468	774	595	939	840	43	44X15X498	21,8
8682538141060	MHT SA811	2X19	80X25	554	520	880	648	1045	890	43	44X15X554	24
8682538140988	MHT SA812	2X21	80X25	600	572	984	691	1149	940	43	44X15X600	26,2



Zor koşulları kolaylaştırır.
Makes difficult conditions ease

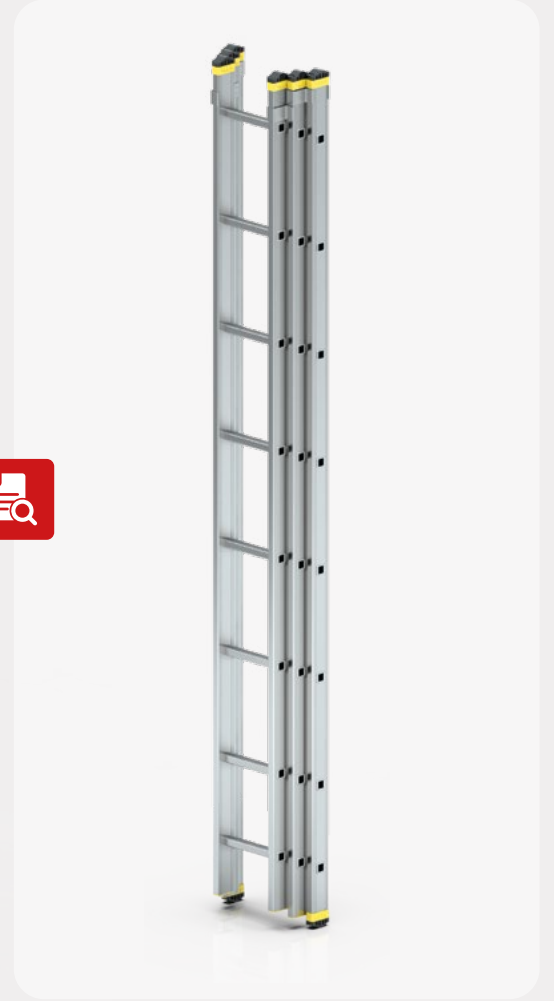

Detail / Detail



WWW.
mhtendustri
.com 

Teknik Özellikler - Technical Specification

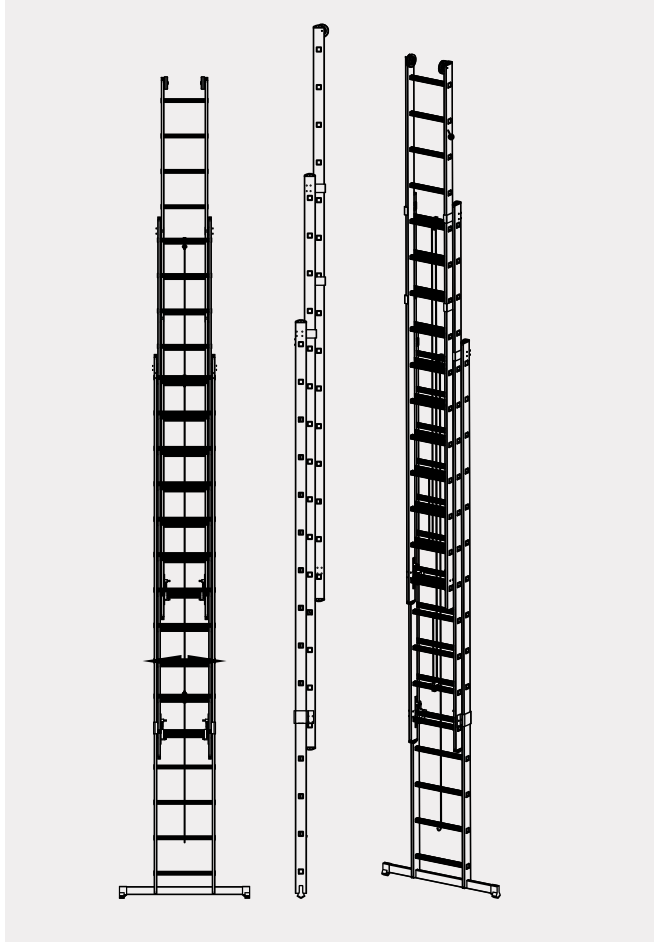

ÖZELLİKLER

- Özel alaşımli alüminyum merdiven
- 3 kademeli kullanım
- Kolay açılıp kapanabilme
- Tek parçalı kullanım
- Kullanıma hazır tek şıklı ambalaj
- Kaymayı önleyen özel tasarımı basamaklar
- Endüstriyel amaçlı kullanım
- Uzun ömürlü Paslanmaz maksimum mukavemet
- Basamakların maksimum mukavemetini ve dengesini sağlamak için profil bağlantı noktasında çift taraflı şişirme

SPECIFICATIONS

- Special alloyed aluminum ladder
- 3 Sectional usage
- Can be used as single section
- Pratical folding away
- Ready to use stylish single pack
- Exclusively designed steps which prevents slipping
- Can be used for Industrial Purpose
- Durable, rustproof, maximum strenght
- Double sided inflating at profile point to provide the maximum strenght and balance of the steps



SKY BEST ÜÇ PARÇALI Sürgülü Alüminyum Merdiven

3 SECTIONAL
INDUSTRIAL LADDER
(SLINDING TYPE)

BARKOD BARCODE	KOD CODE	BASAMAK SAYISI NUMBER OF STEPS	PROFİL PROFILE	1.KADEME YÜKSEKLİK FIRST STAGE HEIGHT	2.KADEME YÜKSEKLİK FIRST STAGE HEIGHT	3.KADEME YÜKSEKLİK FIRST STAGE HEIGHT	ÇALIŞMA YÜKSEKLİĞİ 1 WORKING HEIGHT 1	ÇALIŞMA YÜKSEKLİĞİ 2 WORKING HEIGHT 2	ÇALIŞMA YÜKSEKLİĞİ 3 WORKING HEIGHT 3	DİŞA GENİŞLİK OUT-TO-OUT WIDHT	AMBALAJ (A,B,C) PACKING DIMENSION	AĞIRLIK WEIGHT
8682538141114	MHT S3620	3X6	63x24	190	182	397	305	410	543	48	50X20X190	12
8682538141121	MHT S3625	3X8	63x24	246	234	555	350	482	649	48	50X20X246	15
8682538141138	MHT S3630	3X10	63x24	302	286	660	410	561	754	48	50X20X302	18
8682538141145	MHT S3835	3X12	80X25	358	338	765	465	640	859	48	50X20X358	21
8682538141152	MHT S3840	3X14	80X25	414	390	923	515	745	1017	48	50X20X414	24
8682538141169	MHT S3845	3X15	80X25	442	416	987	542	795	1096	48	50X20X442	27
8682538141176	MHT S3850	3X17	80X25	498	468	1107	595	876	1200	48	50X20X498	30
8682538141183	MHT S3855	3X19	80X25	554	520	1265	648	980	1359	48	50X20X554	33
8682538141107	MHT S3860	3X21	80X25	600	572	1423	691	1064	1517	48	50X20X600	36



Zor koşulları kolaylaştırır.
Makes difficult conditions ease



Detail / Detail

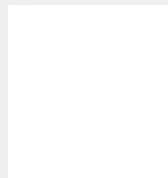
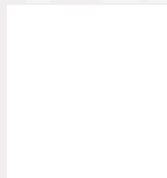
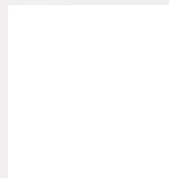

WWW.
mhtendustri
.com

Teknik Özellikler - Technical Specification

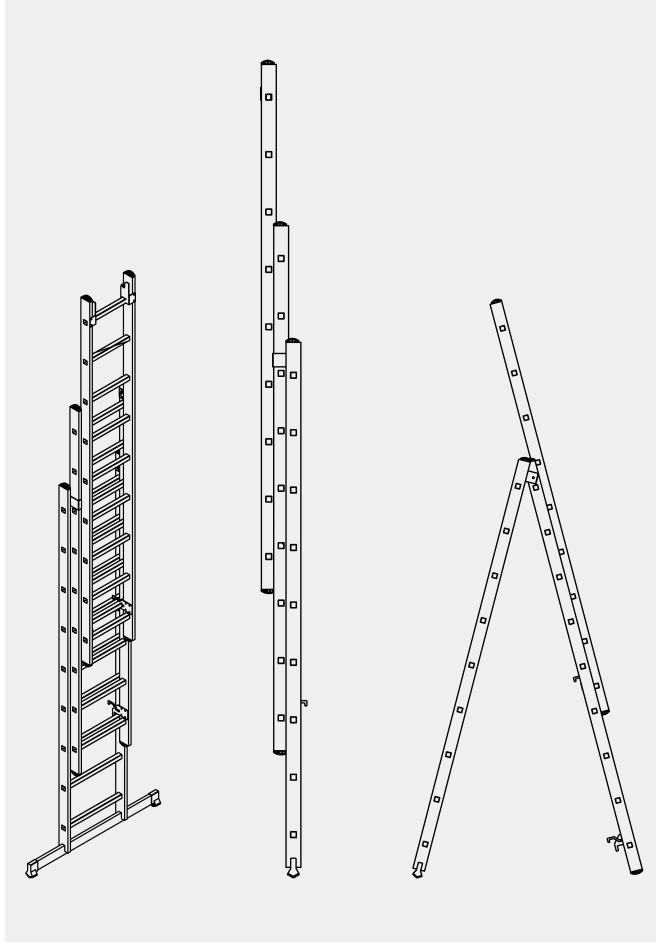

ÖZELLİKLER

- Özel alaşımli alüminyum merdiven
- 3 kademeli kullanım
- Kolay açılıp kapanabilme
- Tek parçalı kullanım
- Kullanıma hazır tek şıklı ambalaj
- Kaymayı önleyen özel tasarımı basamaklar
- Endüstriyel amaçlı kullanım
- Uzun ömürlü Paslanmaz maksimum mukavemet
- Basamakların maksimum mukavemetini ve dengesini sağlamak için profil bağlantı noktasında çift taraflı şişirme

SPECIFICATIONS

- Special alloyed aluminum ladder
- 3 Sectional usage
- Can be used as single section
- Pratical folding away
- Ready to use stylish single pack
- Exclusively designed steps which prevents slipping
- Can be used for Industrial Purpose
- Durable, rustproof, maximum strenght
- Double sided inflating at profile point to provide the maximum strenght and balance of the steps



SKY BEST ÜÇ PARÇALI A Tipi Sürgülü Alüminyum Merdiven

3 SECTIONAL
INDUSTRIAL LADDER
(TYPE A)

BARKOD BARCODE	KOD CODE	BASAMAK SAYISI NUMBER OF STEPS	PROFİL PROFILE	1.KADEME YÜKSEKLİK FIRST STAGE HEIGHT	2.KADEME YÜKSEKLİK FIRST STAGE HEIGHT	3.KADEME YÜKSEKLİK FIRST STAGE HEIGHT	ÇALIŞMA YÜKSEKLİĞİ 1 WORKING HEIGHT 1	ÇALIŞMA YÜKSEKLİĞİ 2 WORKING HEIGHT 2	ÇALIŞMA YÜKSEKLİĞİ 3 WORKING HEIGHT 3	DIŞTAN DIŞA GENİŞLİK OUT-TO-OUT WIDHT	AMBALAJ (A,B,C) PACKING DIMENSION	AĞIRLIK WEIGHT
8682538141237	MHT SA3620	3X6	63x24	190	182	397	305	410	543	48	50X20X190	12,4
8682538141244	MHT SA3625	3X8	63x24	246	234	555	350	482	649	48	50X20X246	16,2
8682538141251	MHT SA3630	3X10	63x24	302	286	660	410	561	754	48	50X20X302	19,3
8682538141268	MHT SA3835	3X12	80X25	358	338	765	465	640	859	48	50X20X358	22,5
8682538141275	MHT SA3840	3X14	80X25	414	390	923	515	745	1017	48	50X20X414	25,8
8682538141282	MHT SA3845	3X15	80X25	442	416	987	542	795	1096	48	50X20X442	29
8682538141299	MHT SA3850	3X17	80X25	498	468	1107	595	876	1200	48	50X20X498	32,2
8682538141305	MHT SA3855	3X19	80X25	554	520	1265	648	980	1359	48	50X20X554	35,5
8682538141220	MHT SA3860	3X21	80X25	600	572	1423	691	1064	1517	48	50X20X600	38,7



Zor koşulları kolaylaştırır.
Makes difficult conditions ease

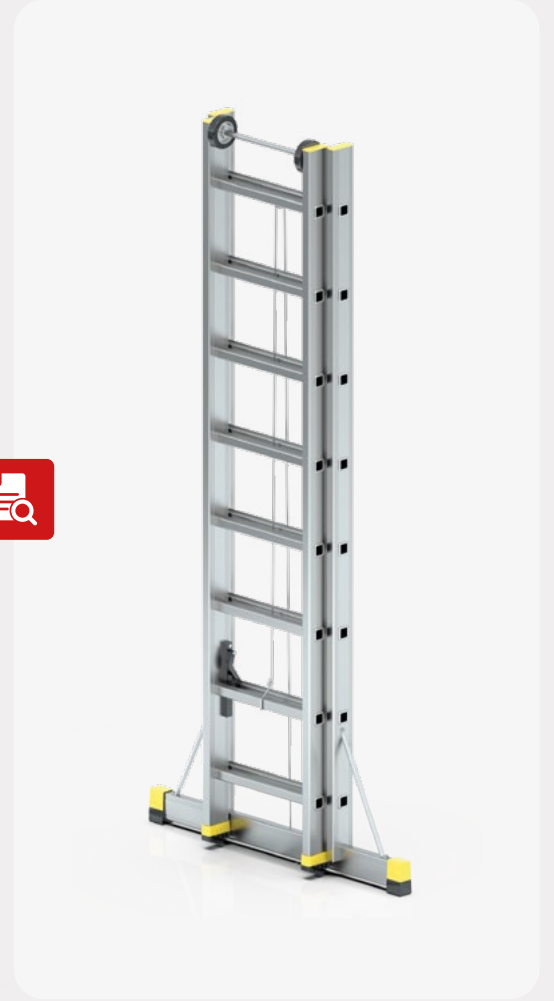

Detail / Detail



WWW.
mhtendustri
.com

Teknik Özellikler - Technical Specification

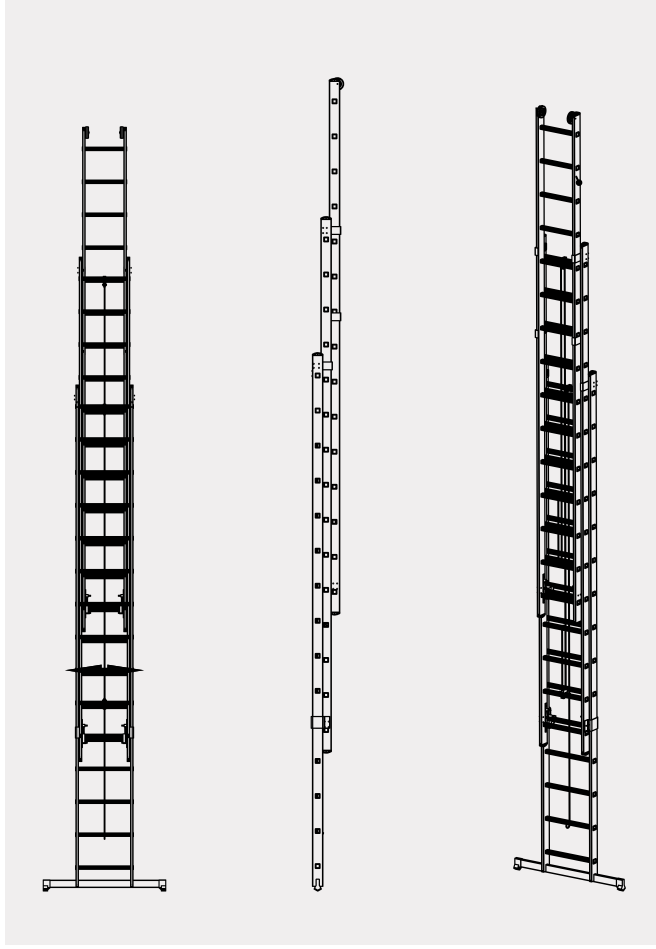

ÖZELLİKLER

- Özel alaşımli alüminyum merdiven
- 3 kademeli kullanım
- Kolay açılıp kapanabilme
- Tek parçalı kullanım
- Kullanıma hazır tek şıklı ambalaj
- Kaymayı önleyen özel tasarımı basamaklar
- Endüstriyel amaçlı kullanım
- Uzun ömürlü Paslanmaz maksimum mukavemet
- Basamakların maksimum mukavemetini ve dengesini sağlamak için profil bağlantı noktasında çift taraflı şişirme

SPECIFICATIONS

- Special alloyed aluminum ladder
- 3 Sectional usage
- Can be used as single section
- Pratical folding away
- Ready to use stylish single pack
- Exclusively designed steps which prevents slipping
- Can be used for Industrial Purpose
- Durable, rustproof, maximum strenght
- Double sided inflating at profile point to provide the maximum strenght and balance of the steps



SKY BEST iPLi MAKARALI Sürgülü Alüminyum Merdiven

RORATY ROLLING
INDUSTRIAL LADDER

BARKOD BARCODE	KOD CODE	BASAMAK SAYISI NUMBER OF STEPS	PROFIL PROFILE	1.KADEME YÜKSEKLİK FIRST STAGE HEIGHT	2.KADEME YÜKSEKLİK FIRST STAGE HEIGHT	ÇALIŞMA YÜKSEKLİĞİ 1 WORKING HEIGHT1	ÇALIŞMA YÜKSEKLİĞİ 2 WORKING HEIGHT 2	DİSTAN DİŞA GENİŞLİK OUT-TO-OUT WIDHT	AMBALAJ (A, B, C) PACKING DIMENSION	AĞIRLIK WEIGHT
8682538141848	MHT004	2X6	80X25	190	289	305	410	43	44X15X190	9
8682538141855	MHT005	2X8	80X25	246	380	350	482	43	44X15X246	11,2
8682538141862	MHT006	2X10	80X25	302	458	410	561	43	44X15X302	14,4
8682538141879	MHT007	2X12	80X25	358	537	465	640	43	44X15X358	15,6
8682538141886	MHT008	2X14	80X25	414	642	515	745	43	44X15X414	18,2
8682538141893	MHT009	2X15	80X25	442	695	542	795	43	44X15X442	19
8682538141909	MHT010	2X17	80X25	498	774	595	876	43	44X15X498	21,1
8682538141916	MHT011	2X19	80X25	554	880	648	980	43	44X15X554	22,3
8682538141923	MHT012	2X21	80X25	600	984	691	1064	43	44X15X600	25,2



Zor koşulları kolaylaştırır.
Makes difficult conditions ease



Detail / Detail



WWW.
mhtendustri
.com 

Teknik Özellikler - Technical Specification

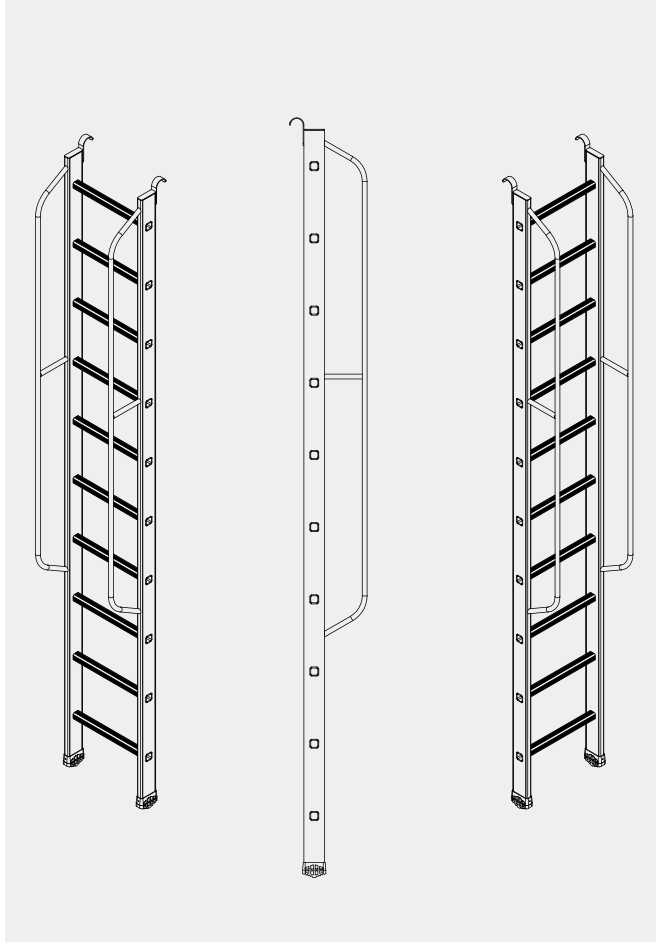

ÖZELLİKLER

- Özel alaşımli alüminyum merdiven
- Kullanıma hazır tek şıklı ambalaj
- Kaymayı önleyen özel tasarımı basamaklar
- Endüstriyel amaçlı kullanım
- Uzun ömürlü Paslanmaz maksimum mukavemet

SPECIFICATIONS

- Special alloyed aluminum ladder
- Ready to use stylish single pack
- Exclusively designed steps which prevents slipping
- Can be used for Industrial Purpose
- Durable, rust proof, maximum strenght



SKY BEST KORKULUKLU KANCALI Merdiven

HANDRIAL ALUMINIUM
INDUSTRIAL LADDER

BARKOD BARCODE	KOD CODE	BASAMAK SAYISI NUMBER OF STEPS	PROFİL PROFILE	1.KADEME YÜKSEKLİK FIRST STAGE HEIGHT	CALIŞMA YÜKSEKLİĞİ WORKING HEIGHT	DİSTAN DİŞA GENİSLİK OUT-TO-OUT WIDHT	AMBALAJ (A, B, C) PACKING DIMENSION	AĞIRLIK WEIGHT
8682538141695	MHT KK820	6	80X25	195	305	43	44X40X195	4,9
8682538141701	MHT KK825	8	80X25	251	350	43	44X40X251	6
8682538141718	MHT KK830	10	80X25	307	410	43	44X40X307	7,6
8682538141725	MHT KK835	12	80X25	363	465	43	44X40X363	8,7
8682538141732	MHT KK840	14	80X25	419	515	43	44X40X419	9,9
8682538141749	MHT KK845	15	80X25	447	542	43	44X40X447	10,5
8682538141756	MHT KK850	17	80X25	503	595	43	44X40X503	11,7
8682538141763	MHT KK855	19	80X25	559	648	43	44X40X559	13
8682538141770	MHT KK860	21	80X25	605	691	43	44X40X605	14



Zor koşulları kolaylaştırır.
Makes difficult conditions ease



Detail / Detail

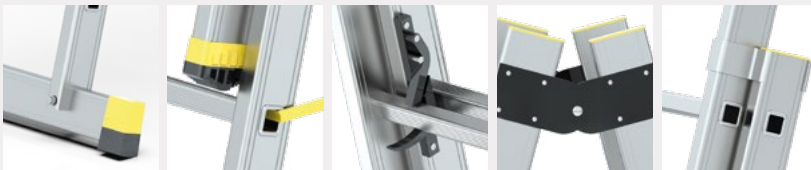

WWW.
mhtendustri
.com

Teknik Özellikler - Technical Specification

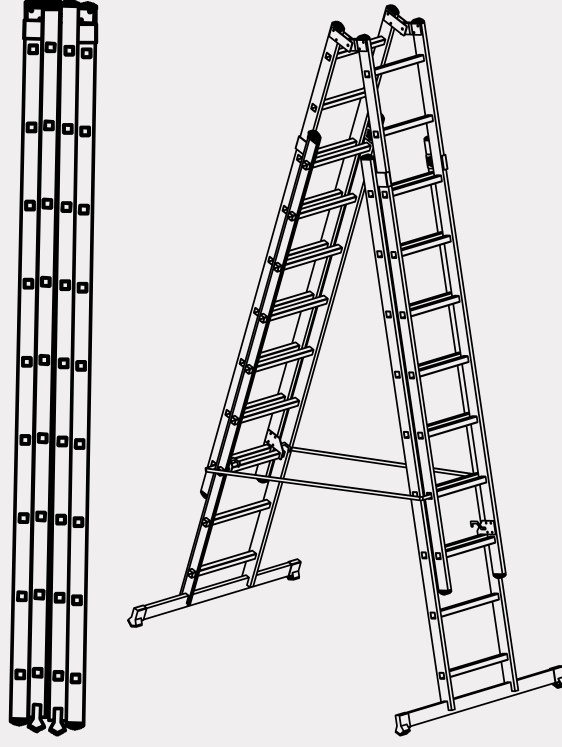

ÖZELLİKLER

- Özel alaşımli alüminyum merdiven
- 2 kademeli kullanım
- Kolay açılıp kapanabilme
- Tek parçalı kullanım
- Kullanıma hazır tek şıklı ambalaj
- Kaymayı önleyen özel tasarımı basamaklar
- Endüstriyel amaçlı kullanım
- Uzun ömürlü Paslanmaz maksimum mukavemet
- Basamakların maksimum mukavemetini ve dengesini sağlamak için profil bağlantı noktasında çift taraflı şişirme

SPECIFICATIONS

- Special alloyed aluminum ladder
- 2 sectional usage
- Can be used as single section
- Practical folding away
- Ready to use stylish single pack
- Exclusively designed steps which prevents slipping
- Can be used for Industrial Purpose
- Durable, rust proof, maximum strenght
- Double sided inflating at profile point to provide the maximum strenght and balance of the steps



SKY BEST ÇİFT Şürgülü Alüminyum Merdiven

DOUBLE SLIDING
LADDER

BARKOD BARCODE	KOD CODE	BASAMAK SAYISI NUMBER OF STEPS	PROFİL PROFILE	1.KADEME YÜKSEKLİK FIRST STAGE HEIGHT	2.KADEME YÜKSEKLİK FIRST STAGE HEIGHT	ÇALIŞMA YÜKSEKLİĞİ 1 WORKING HEIGHT1	ÇALIŞMA YÜKSEKLİĞİ 2 WORKING HEIGHT 2	DİŞAN DİŞA GENİŞLİK OUT-TO-OUT WIDHT	AMBALAJ (A,B,C) PACKING DIMENSION	AĞIRLIK WEIGHT
8682538140636	MHTC0020	4X6	80X25	190	289	305	410	43	50X35X190	15,9
8682538140643	MHTC0025	4X8	80X25	246	380	350	482	43	50X35X246	19,3
8682538140650	MHTC0030	4X10	80X25	302	458	410	561	43	50X35X302	22,7
8682538140667	MHTC0035	4X12	80X25	358	537	465	640	43	50X35X358	26
8682538140674	MHTC0040	4X14	80X25	414	642	515	745	43	50X35X414	29,4
8682538140681	MHTC0045	4X15	80X25	442	695	542	795	43	50X35X442	32,3
8682538140698	MHTC0050	4X17	80X25	498	774	595	876	43	50X35X498	35,5
8682538140704	MHTC0055	4X19	80X25	554	880	648	980	43	50X35X554	39
8682538141435	MHTC0060	4X21	80X25	600	984	691	1064	43	50X35X600	42,5

SKY PRATIX MERDIVEN



SKY PRATIX
MERDİVEN GRUBU

SKYPRATIX LADDER GROUP

WWW.
mhtendustri
.com 



Zor koşulları kolaylaştırır.
Makes difficult conditions ease



Detail / Detail



www.
mhtendustri
.com 

Teknik Özellikler - Technical Specification

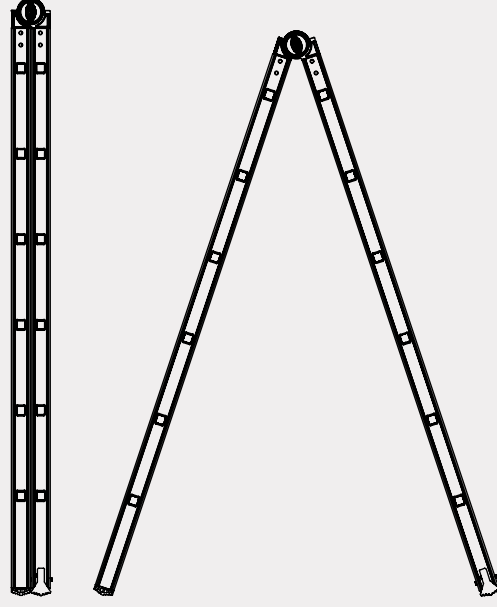

ÖZELLİKLER

- Özel alaşımli alüminyum merdiven
- Akıllı kilit sistemi sayesinde çok amaçlı kullanım
- Katlanabilmesi sayesinde az yer kaplar
- Kolay açılıp kapanabilme özelliği
- Kaymayı önleyen özel tasarımı basamaklar
- Endüstriyel amaçlı kullanım
- Uzun ömürlü Paslanmaz maksimum mukavemet

SPECIFICATIONS

- Special alloyed aluminum ladder
- Multi-purpose usage thanks to the smart locking system
- Folding structure provides less space consumption when the ladder is folded
- Practical folding away
- Exclusively designed steps which prevents slipping
- Can be used for Industrial Purpose
- Durable, rust proof, maximum strenght



SKY PRATIX FONKSİYONEL Katlanır Merdiven

FUNCTIONAL ACROBAT
LADDER

BARKOD	KOD	BASAMAK SAYISI	"PROFİL (mm)"	1. KADEME YÜKSEKLİK (cm)	2. KADEME YÜKSEKLİK (cm)	3. KADEME YÜKSEKLİK (cm)	"DİŞAN DIŞA GENİŞLİK (cm)"	ÇALIŞMA YÜKSEKLİĞİ-1	ÇALIŞMA YÜKSEKLİĞİ-2	AĞIRLIK (WEIGHT)	"AMBALAJ (cm)"
8682538141787	MHT 606	2X3	63X24	95	89	178	37	202	265	8	45x15x95
8682538141794	MHT 608	2X4	63X24	123	115	230	37	228	291	9,8	45x15x123
8682538141800	MHT 610	2X5	63X24	151	141	282	37	254	317	11,7	45x15x151
8682538141817	MHT 612	2X6	63X24	179	168	336	37	281	343	13,5	45x15x179
8682538141824	MHT 614	2X7	63X24	207	194	388	37	307	369	15,4	45x15x207
8682538141831	MHT 616	2X8	63X24	235	220	440	37	348	395	16,3	45x15x235
8682538140858	MHT 618	2X9	63X24	263	247	494	37	360	421	17,25	45x15x263
8682538140957	MHT 620	2X10	63X24	291	273	546	37	386	447	18,2	45x15x291



Zor koşulları kolaylaştırır.
Makes difficult conditions ease



Detail / Detail

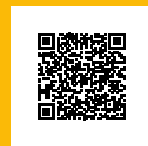

www.
mhtendustri
.com

Teknik Özellikler - Technical Specification

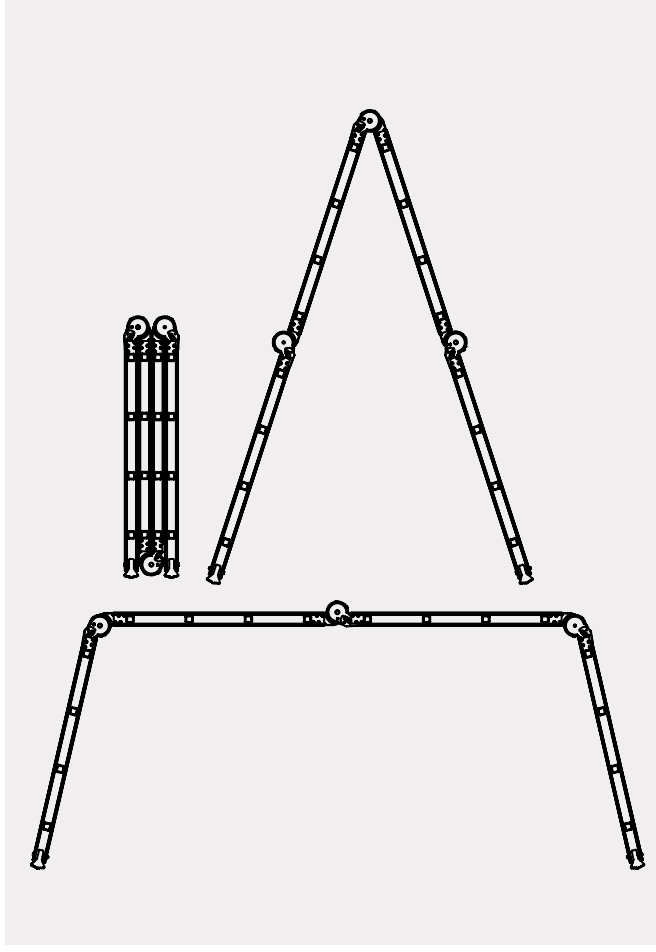

ÖZELLİKLER

- Özel alaşımli alüminyum merdiven
- Akıllı kilit sistemi sayesinde çok amaçlı kullanım
- Katlanabilmesi sayesinde az yer kaplar
- Kolay açılıp kapanabilme özelliği
- Kaymayı önleyen özel tasarımı basamaklar
- Endüstriyel amaçlı kullanım
- Uzun ömürlü Paslanmaz maksimum mukavemet

SPECIFICATIONS

- Special alloyed aluminum ladder
- Multi-purpose usage thanks to the smart locking system
- Folding structure provides less space consumption when the ladder is folded
- Practical folding away
- Exclusively designed steps which prevents slipping
- Can be used for Industrial Purpose
- Durable, rust proof, maximum strenght



SKY PRATIX KIRMALI Katlanır Merdiven

TWO PIECE ALUMINUM
FOLDING LADDER

BARKOD	KOD	BASAMAK SAYISI	"PROFİL (mm)"	"TAM AÇIK (WIDE OPEN) (cm)"	"YARIM AÇIK (HALF OPEN) (cm)"	"DİŞAN DIŞA GENİŞLİK (cm)"	YATAY AÇIKLIK (HORIZONTAL OPEN) (cm)	TAM KAPALI (FULL CLOSED) (cm)	AĞIRLIK (WEIGHT) (kg) ±%5	"AMBALAJ (cm)"
8682538141947	MHT 643	3	63X24	347	173	37	95	91	12,75	37X28X95
8682538141954	MHT 644	4	63X24	441	220	37	125	119	14,55	37X28X125
8682538141961	MHT 645	5	63X24	535	267	37	155	147	16,30	37X28X155
8682538141978	MHT 646	6	63X24	630	315	37	185	175	18,55	37X28X185
8682538141657	MHT 642	2	63X24	253	127	37	65	63	10,50	37X28X65

SKY MASTER MERDIVEN



***SKY MASTER
MERDİVEN GRUBU***

SKY MASTER LADDER GROUP

WWW.
mhtendustri
.com 



Zor koşulları kolaylaştırır.
Makes difficult conditions ease



Detail / Detail



WWW.
mhtendustri
.com 

Teknik Özellikler - Technical Specification

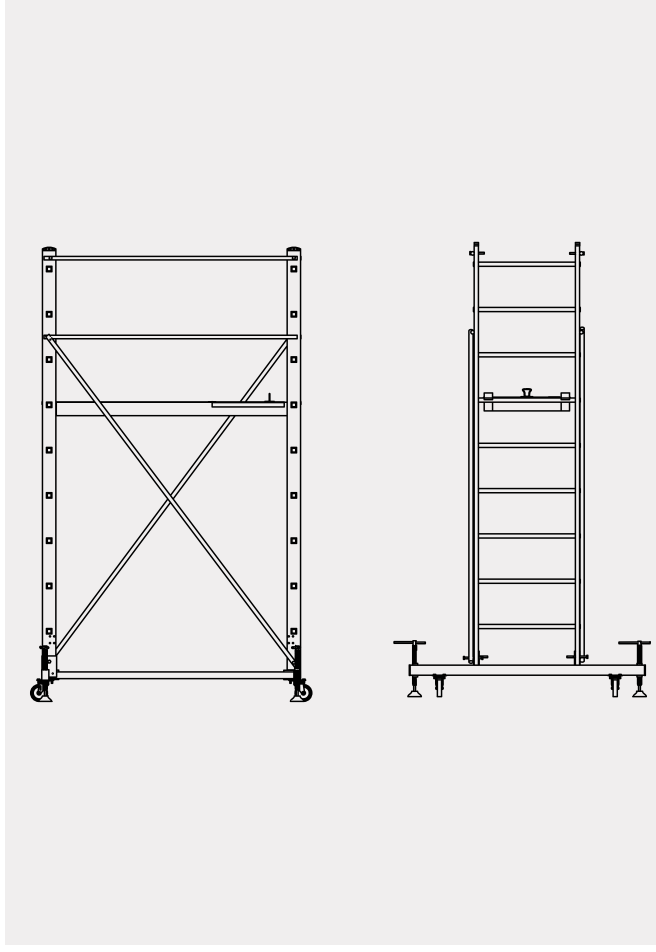

ÖZELLİKLER

- Özel alaşımli alüminyum iskele merdiven
- Platform sayesinde rahat hareket edebilme
- Tekerler sayesinde rahat hareket edebilme ve sabitleme
- Platform kapak sayesinde kısa sürede istenilen çalışma ortamına ulaşma
- Yan kollar sayesinde emniyeti sağlama ve sallantıyı engelleme
- Kolay sökülüp takılabilme ve demonte hale gelebilme
- Kaymayı önleyen özel tasarımı basamaklar ve platform
- Uzun ömürlü Paslanmaz maksimum mukavemet

SPECIFICATIONS

- Special alloyed aluminum ladder
- Easy movement thanks to platform
- With wheels, easy mobility and anchorage
- Thanks to platform cover, easy access to the intended work environment in short time
- Thanks to side bars providing safety and shake prevention
- Easy to assemble and disassemble
- Exclusively designed steps which prevents slipping
- Durable, rust proof, maximum strenght



SKY MASTER TEK EKLI İSKELE

SINGLE STEP
ALUMINIUM
SCAFFOLDING

BARKOD BARCODE	KOD CODE	BASAMAK SAYISI NUMBER OF STEPS	PROFİL PROFILE	TAM AÇIK (A) cm WIDE OPEN (A) cm	PLATFORM YÜKSEKLİĞİ (B) PLATFORM HEIGHT cm (B)	ÇALIŞMA YÜKSEKLİĞİ (C) cm WORKING HEIGHT	AYAKLARININ AÇILDIĞI MAX. GENİŞLİK (D) cm MAX WIDHT WHEN LEGS ARE OPENED	AMBALAJ (A, B, C) PACKING DIMENSION	AĞIRLIK WEIGHT
8682538141503	MHT T020	6	80X25	210	140	305	50X215X205	70X225X60	30
8682538141510	MHT T025	8	80X25	266	196	361	50X215X205	70X280X60	34
8682538141527	MHT T030	10	80X25	322	252	417	50X215X205	70X340X60	39
8682538141534	MHT T035	12	80X25	378	308	473	50X215X205	70X390X60	43
8682538141541	MHT T040	14	80X25	434	364	529	50X215X205	70X450X60	48
8682538141558	MHT T050	17	80X25	490	420	585	50X215X205	70X540X60	52



Zor koşulları kolaylaştırır.
Makes difficult conditions ease



Detail / Detail

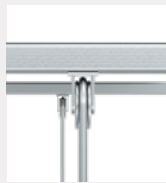

WWW.
mhtendustri
.com 

Teknik Özellikler - Technical Specification

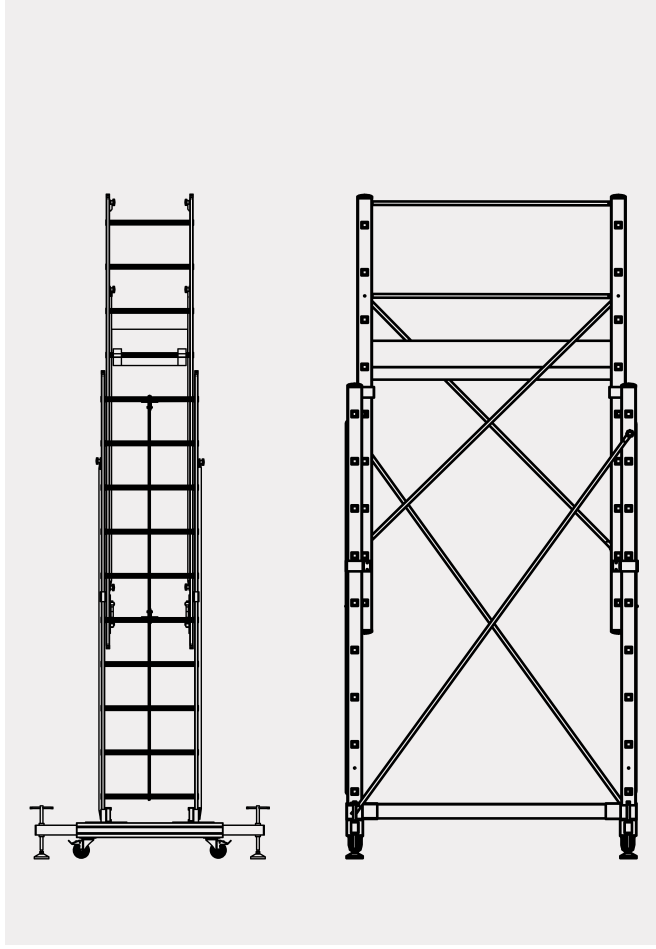

ÖZELLİKLER

- Özel alaşımli alüminyum iskele merdiven
- Platform sayesinde rahat hareket edebilme
- Tekerler sayesinde rahat hareket edebilme ve sabitleme
- Platform kapak sayesinde kısa sürede istenilen çalışma ortamına ulaşma
- Yan kollar sayesinde emniyeti sağlama ve sallantıyı engelleme
- Kolay sökülüp takılabılme ve demonte hale gelebilme
- Kaymayı önleyen özel tasarımı basamaklar ve platform
- Uzun ömürlü Paslanmaz maksimum mukavemet

SPECIFICATIONS

- Special alloyed aluminum ladder
- Easy movement thanks to platform
- With wheels, easy mobility and anchorage
- Thanks to platform cover, easy access to the intended work environment in short time
- Thanks to side bars providing safety and shake prevention
- Easy to assemble and disassemble
- Exclusively designed steps which prevents slipping
- Durable, rust proof, maximum strenght



SKY MASTER XL İSKELE

ALUMINIUM
MEGA
SCAFFOLDING

BARKOD BARCODE	KOD CODE	BASAMAK SAYISI NUMBER OF STEPS	PROFİL PROFILE	1.KADEME YÜKSEKLİK FIRST STAGE HEIGHT	2.KADEME YÜKSEKLİK FIRST STAGE HEIGHT	ÇALIŞMA YÜKSEKLİĞİ (C) cm WORKING HEIGHT	DİŞAN DIŞA GENİŞLİK OUT-TO-OUT WIDHT	AMBALAJ (A,B,C) PACKING DIMENSION	AĞIRLIK WEIGHT
8682538140179	MHT P4	6	80X25	340	270	435	50X215X205	70X225X60	60
8682538140186	MHT P5	8	80X25	440	355	520	50X215X205	70X280X60	66
8682538140193	MHT P6	10	80X25	550	445	610	50X215X205	70X340X60	75
8682538140209	MHT P7	12	80X25	660	550	715	50X215X205	70X390X60	83
8682538140216	MHT P8	14	80X25	740	605	770	50X215X205	70X450X60	90
8682538140223	MHT P10	17	80X25	920	805	970	50X215X205	70X540X60	97



Zor koşulları kolaylaştırır.
Makes difficult conditions ease

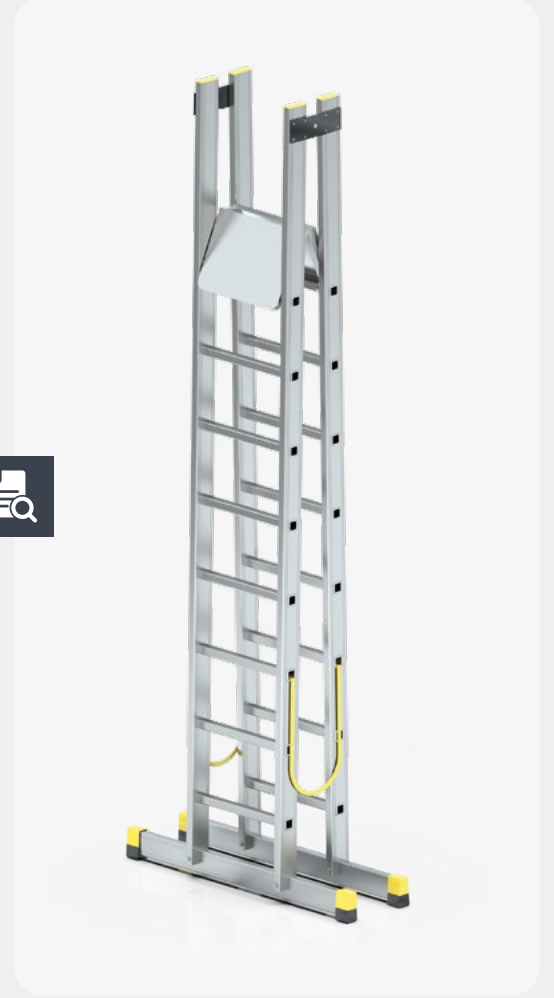
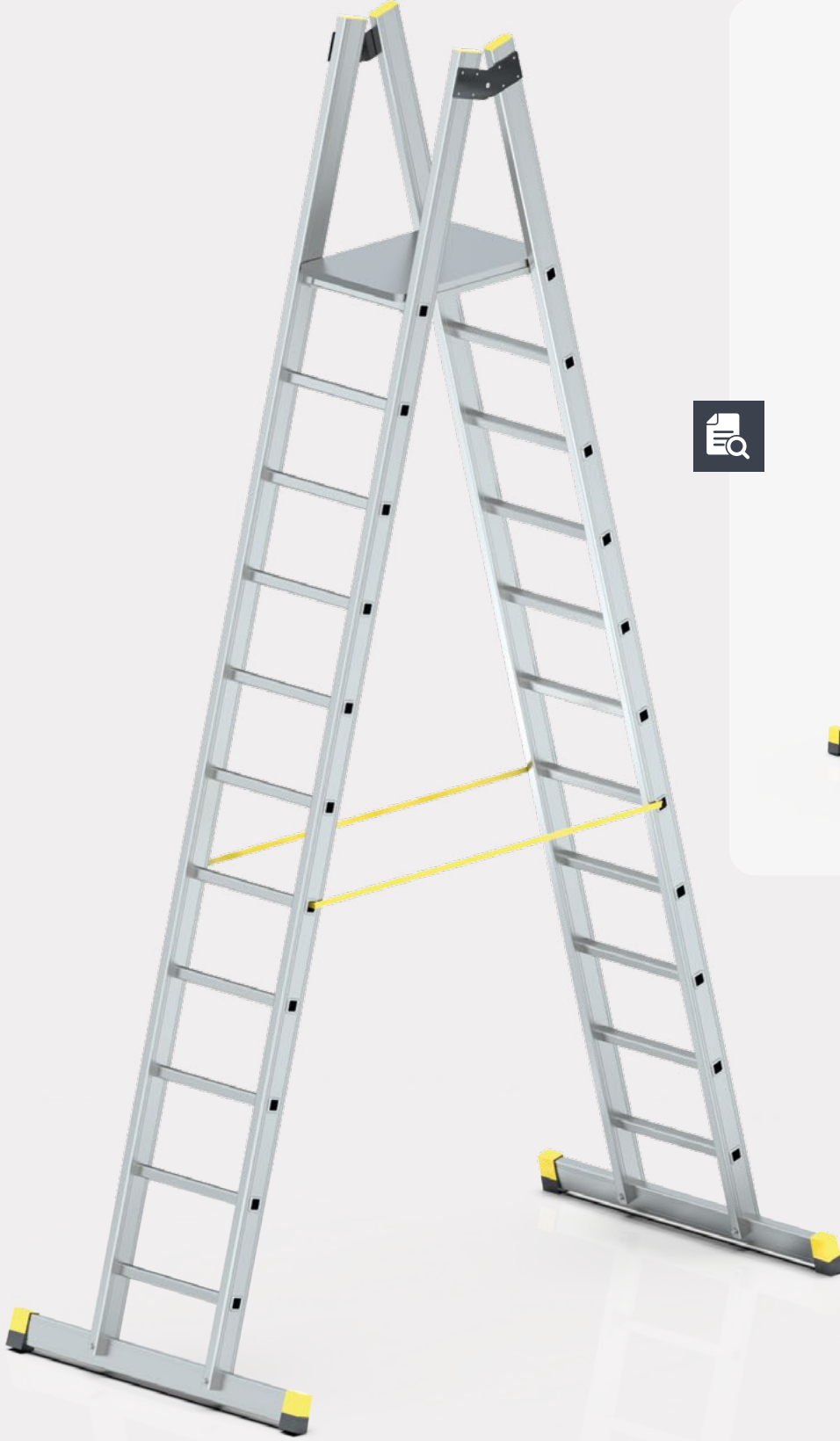

Detail / Detail

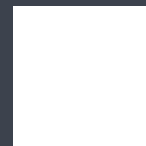
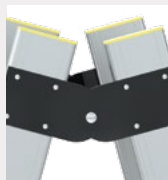

WWW.
mhtendustri
.com

Teknik Özellikler - Technical Specification

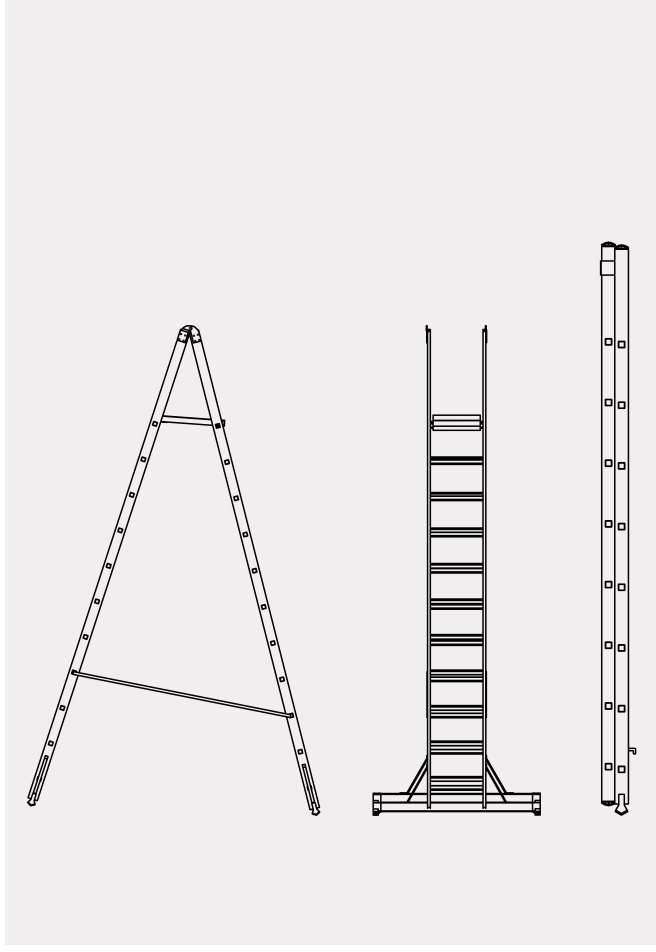

ÖZELLİKLER

- Özel alaşımlı alüminyum merdiven
- Kaymayı önleyen özel tasarımlı basamaklar
- Endüstriyel amaçlı kullanım
- Güvenli korkuluk sistemi
- Kolay açılıp kapanabilme özelliği
- Güçlendirilmiş ayak desteği
- Bağlantı noktalarında özel kilit
- Uzun ömürlü paslanmaz maksimum mukavemet

SPECIFICATIONS

- Special alloyed aluminum ladder
- Special designed steps which prevents slipping
- Can be used for Industrial Purpose
- Safety rail system
- Easy to fold
- Fortified leg support
- Special lock on junction
- Durable, rustproof and maximum endurance



SKY MASTER A TİPİ PLATFORMLU ALÜMİNYUM MERDİVEN

FOLDABLE
PLATFORM
LADDER

BARKOD	KOD	BASAMAK SAYISI	"PROFİL (mm)"	1. KADEME YÜKSEKLİK (cm)	2. KADEME YÜKSEKLİK (cm)	PLATFORM YÜKSEKLİĞİ	"AMBALAJ (cm)"	AĞIRLIK (WEIGHT) kg ±%5
	MHTAPM20	6+1	80X25	243	320	185	243X20X43	15
8682538141985	MHTAPM25	8+1	80X25	298	380	240	298X20X43	18,2
8682538141992	MHTAPM30	10+1	80X25	353	430	296	353X20X43	20,3
	MHTAPM35	12+1	80X25	410	490	347	410X20X43	23
8682538142005	MHTAPM40	14+1	80X25	465	545	385	465X20X43	25
	MHTAPM45	15+1	80X25	494	570	427	494X20X43	27
8682538141190	MHTAPM50	17+1	80X25	550	630	480	550X20X43	33
8682538142012	MHTAPM55	19+1	80X25	604	680	536	604X20X43	37
8682538141206	MHTAPM60	21+1	80X25	660	740	600	660X20X43	40



Zor koşulları kolaylaştırır.
Makes difficult conditions ease



Detail / Detail



WWW.
mhtendustri
.com 

Teknik Özellikler - Technical Specification



ÖZELLİKLER

- Özel alaşımli alüminyum merdiven
- Kaymayı önleyen özel tasarımlı basamaklar
- Endüstriyel amaçlı kullanım
- Güvenli korkuluk sistemi
- Kolay açılıp kapanabilme özelliği
- Güçlendirilmiş ayak desteği
- Bağlantı noktalarında özel kilit
- Uzun ömürlü paslanmaz maksimum mukavemet

SPECIFICATIONS

- Special alloyed aluminum ladder
- Special designed steps which prevents slipping
- Can be used for Industrial Purpose
- Safety rail system
- Easy to fold
- Fortified leg support
- Special lock on junction
- Durable, rustproof and maximum endurance



SKY MASTER A TİPİ PLATFORMLU ALÜMİNYUM MERDİVEN

FOLDABLE
PLATFORM
LADDER

BARKOD BARCODE	KOD CODE	BASAMAK SAYISI NUMBER OF STEPS	PROFİL PROFILE	YÜKSEKLİK cm (A) FULL HEIGHT cm (A)	AÇIK YÜKSEKLİK (B) OPEN HEIGHT (B)	PLATFORM YÜKSEKLİĞİ cm (C) PLATFORM HEIGHT cm (C)	PLATFORM GENİŞLİĞİ (D) PLATFORM WIDTH (D)	AYAKLARIN AÇILDIĞI MAX GENİŞLİK (E) cm MAX WIDTH WHEN LEGS ARE OPENED cm (E)	AMBALAJ (A,B,C) PACKING DIMENSION	1 ADET M3 UNIT/ VOLUME
8682538140551	MHT TPM03	3+1	80X25	187	172	104	57X62	143	53X20X187	10
8682538140568	MHT TPM04	4+1	80X25	214	198	132	57X62	163	53X20X214	11,6
8682538140575	MHT TPM05	5+1	80X25	241	222	157	57X62	185	53X20X241	13,2
8682538140582	MHT TPM06	6+1	80X25	268	248	182	57X62	205	53X20X268	14,8
8682538140599	MHT TPM07	7+1	80X25	295	272	207	57X62	225	53X20X313	16,4
8682538140605	MHT TPM08	8+1	80X25	323	298	233	57X62	245	53X20X323	18

EV TIPI MERDIVEN



EV TİPİ
MERDİVEN GRUBU

HOUSE TYPE LADDER GROUP

WWW.
mhtendustri
.com 



Zor koşulları kolaylaştırır.
Makes difficult conditions ease

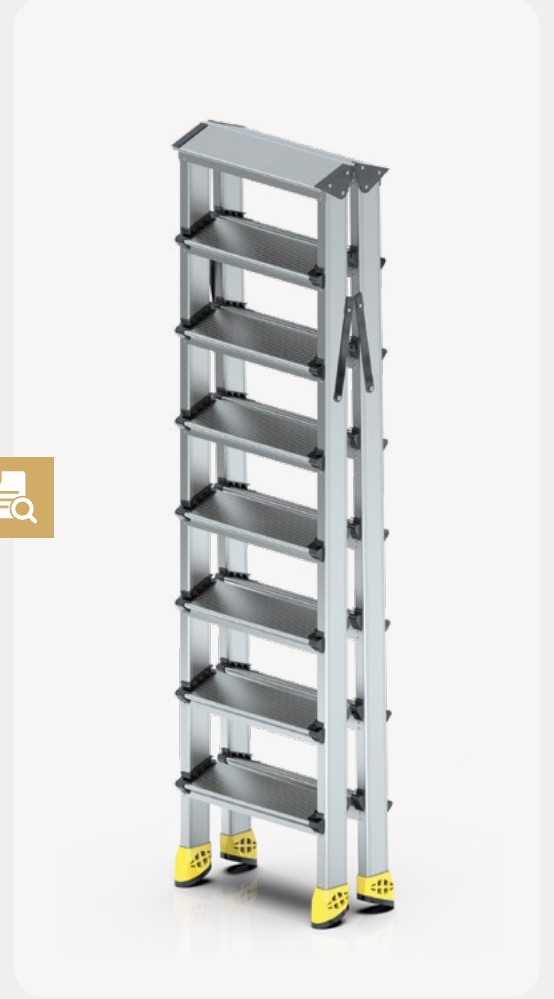

Detail / Detail



WWW.
mhtendustri
.com 

Teknik Özellikler - Technical Specification

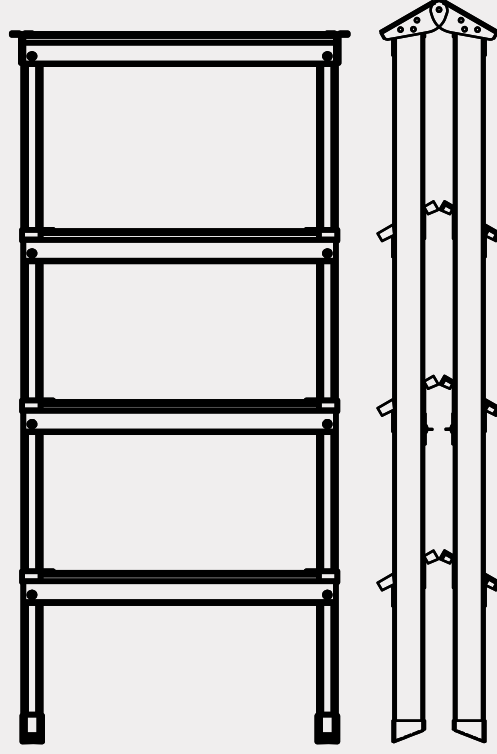

ÖZELLİKLER

- Özel alaşımli alüminyum merdiven
- Kolay açılıp kapanabilme
- Çift taraflı çıkış ve kullanabilme
- Kullanıma hazır tek şıklı ambalaj
- Çizilmeyi önleyen plastik takozlar
- Kaymayı önleyen özel tasarımı basamaklar
- Ev ve işyerlerinde dekoratif kullanım
- Çok hafif ve yük taşımada kuvvetli
- Uzun ömürlü Paslanmaz maksimum mukavemet

SPECIFICATIONS

- Special alloyed aluminum ladder
- Easy to fold away
- Easy to climb and use from both sides
- Ready to use stylish single pack
- Plastic wedges which prevents scuffing
- Exclusively designed steps which prevents slipping
- Decorative usage for both home and industrial use
- Very light weight and high resistance to heavy loading
- Durable, rustproof and maximum endurance



SKY GOLD ÇİFT TARAFLI Merdiven

ALUMINUM
MEGA LADDER

BARKOD BARCODE	KOD CODE	BASAMAK SAYISI NUMBER OF STEPS	PROFİL PROFILE	1.KADEME YÜKSEKLİK FIRST STAGE HEIGHT	2.KADEME YÜKSEKLİK FIRST STAGE HEIGHT	ÇALIŞMA YÜKSEKLİĞİ WORKING HEIGHT	AMBALAJ (A,B,C) PACKING DIMENSION	AĞIRLIK WEIGHT
8682538140391	MHT G02	2+2	50X20	47	42	187	38X16X47	1,65
8682538140407	MHT G03	3+3	50X20	73	68	213	38X16X73	2,25
8682538140414	MHT G04	4+4	50X20	96	91	236	43X16X96	3,35
8682538140421	MHT G05	5+5	50X20	119	114	259	46X16X119	4
8682538140438	MHT G06	6+6	50X20	143	138	283	49X16X143	5
8682538140445	MHT G07	7+7	50X20	165	160	305	51X16X165	6
8682538140452	MHT G08	8+8	50X20	187	182	327	53X16X187	6,65
8682538140469	MHT G09	9+9	50X20	210	205	350	56X16X210	7,6
8682538140476	MHT G10	10+10	50X20	233	228	373	58X16X233	8,9



Zor koşulları kolaylaştırır.
Makes difficult conditions ease

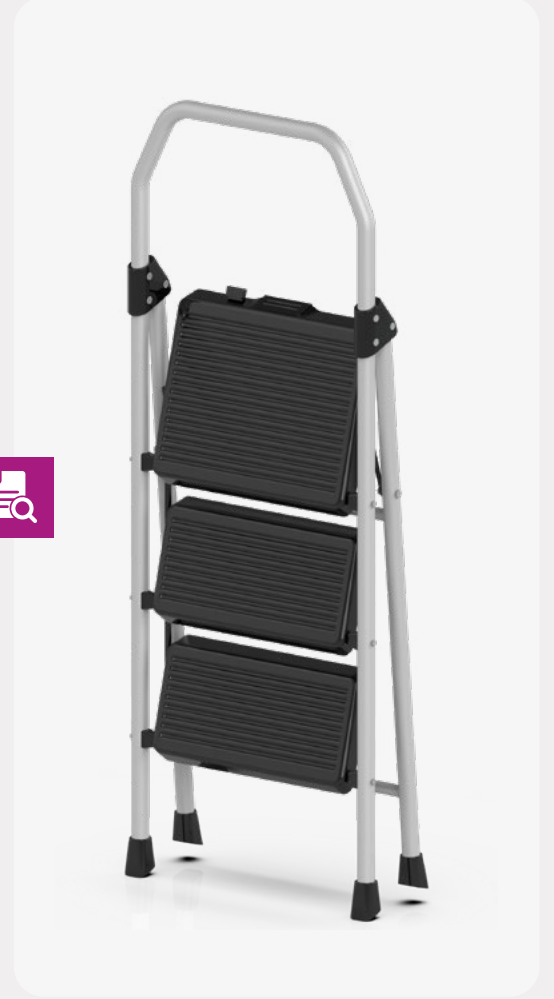
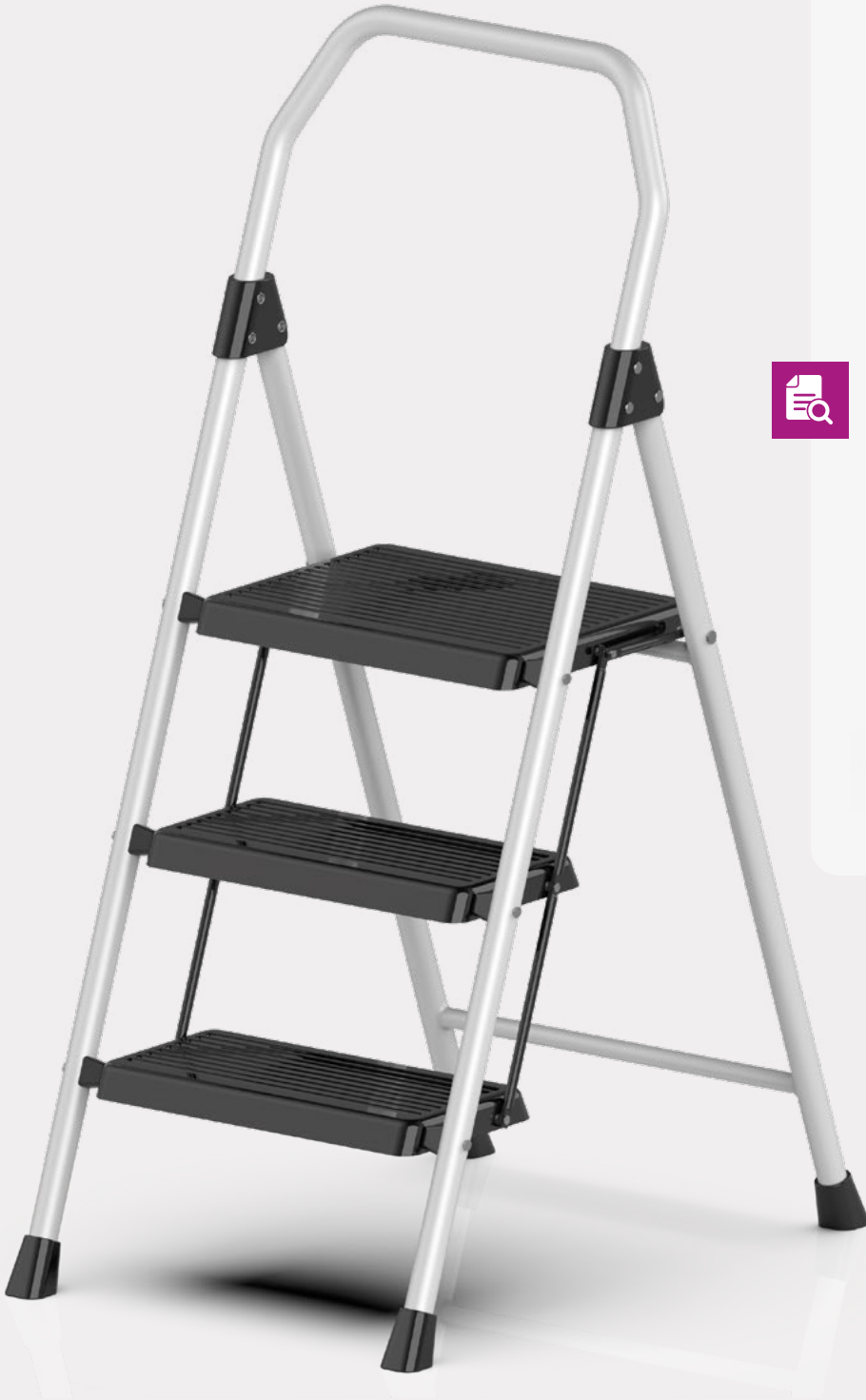

Detail / Detail



WWW.
mhtendustri
.com

Teknik Özellikler - Technical Specification

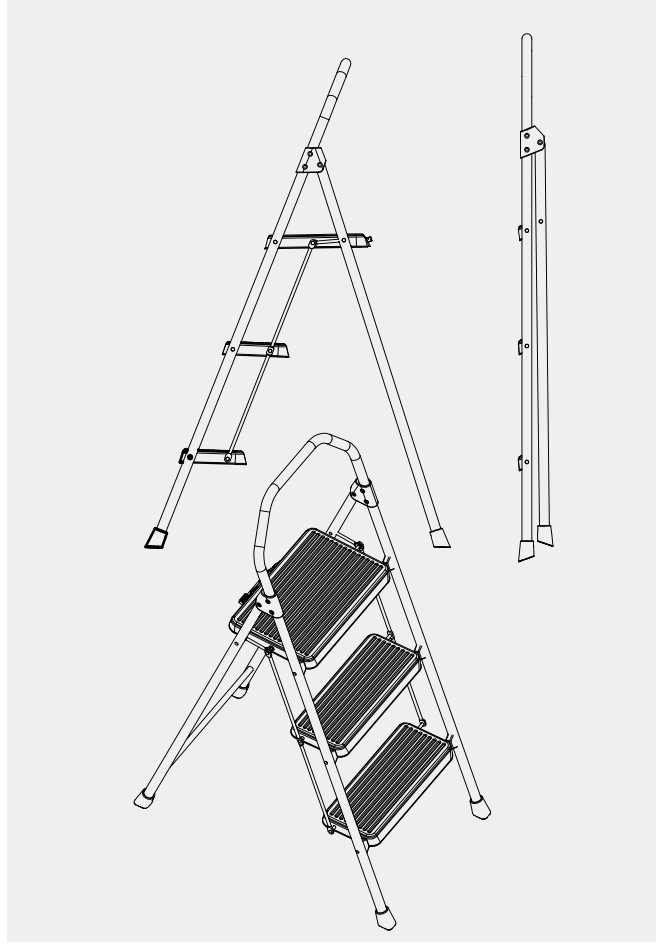

ÖZELLİKLER

- Elektrostatik fırınlanmış boyalı metal aksesuarlar
- Kolay açılıp kapanabilme
- Kullanıma hazır tekli şık ambalaj
- Kaymayı önleyen plastik ayak takozlar
- Kaymayı önleyen özel tasarımı basamaklar
- Ev ve işyerlerinde dekoratif kullanım
- Güvenlik kilitle
- Plastik Kaplı Tutma Yeri

SPECIFICATIONS

- Electrostatically dyed metal accessories
- Practical folding away
- Ready to use in stylish single pack
- Plastic wedges which prevents slipping
- Exclusively designed steps which prevents slipping
- Decorative usage for both home and industrial use
- With safety lock
- Handle covered with polyurethane



SKY GOLD KÖŞELİ MERDİVEN

PRACTICAL
METAL STEP
LADDER

BARKOD BARCODE	KOD CODE	BASAMAK SAYISI NUMBER OF STEPS	PROFİL PROFILE	1.KADEME YÜKSEKLİK FIRST STAGE HEIGHT	2.KADEME YÜKSEKLİK FIRST STAGE HEIGHT	PLATFORM YÜKSEKLİĞİ PLATFORM HEIGHT	ÇALIŞMA YÜKSEKLİĞİ WORKING HEIGHT	AMBALAJ (A,B,C) PACKING DIMENSION	AĞIRLIK WEIGHT
8682538141602	MHT E102	2	21x1,5	113	104	67	232	42X16X115	3,7
8682538141619	MHT E103	3	21x1,5	138	127	90	255	42X16X140	5
8682538141626	MHT E104	4	21x1,5	163	150	113	278	42X16X165	6,2



Zor koşulları kolaylaştırır.
Makes difficult conditions ease

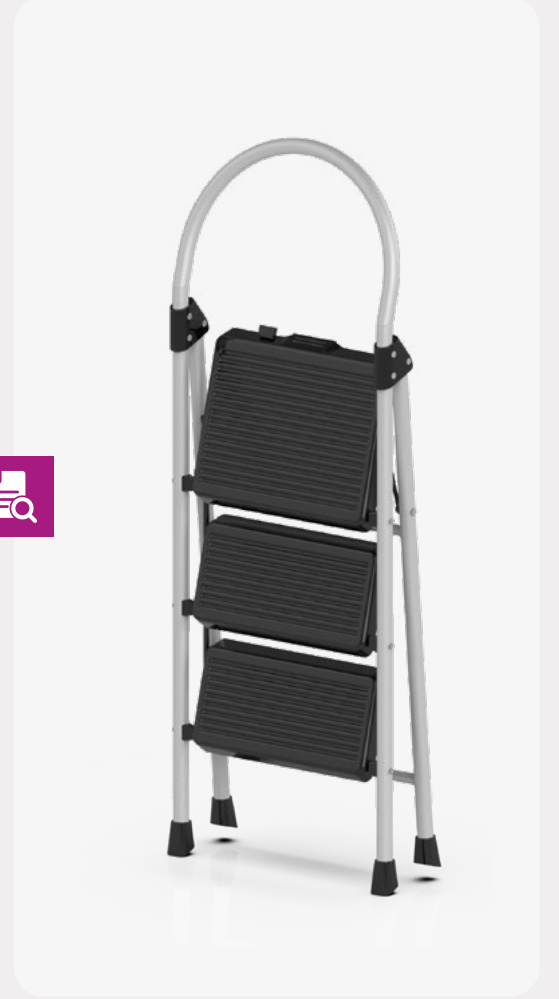

Detail / Detail



WWW.
mhtendustri
.com

Teknik Özellikler - Technical Specification

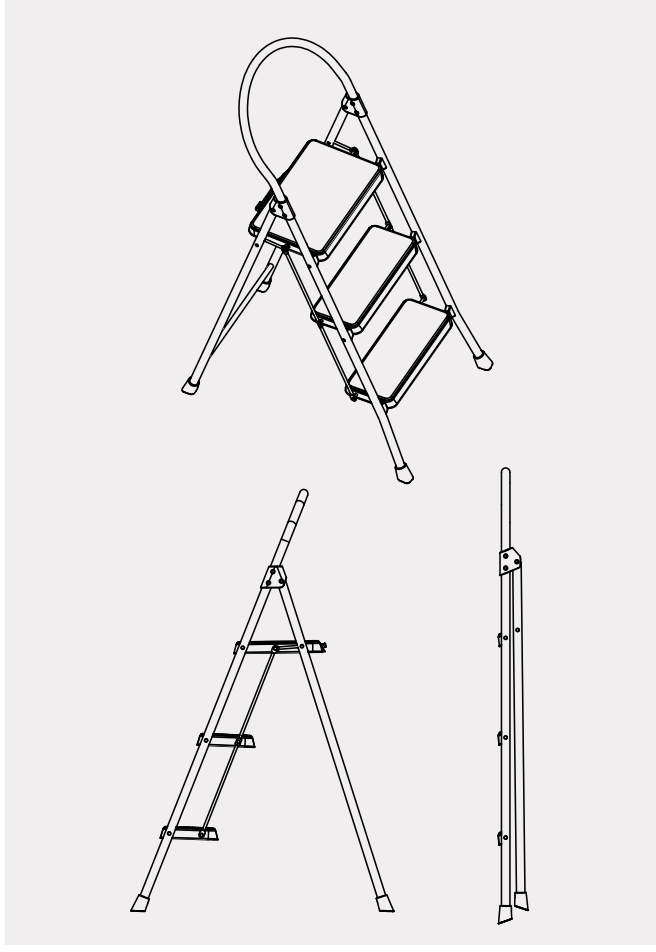

ÖZELLİKLER

- Elektrostatik fırınlanmış boyalı metal aksesuarlar
- Kolay açılıp kapanabilme
- Kullanıma hazır tekli şık ambalaj
- Kaymayı önleyen plastik ayak takozlar
- Kaymayı önleyen özel tasarımı basamaklar
- Ev ve işyerlerinde dekoratif kullanım
- Güvenlik kilitle
- Plastik Kaplı Tutma Yeri

SPECIFICATIONS

- Electrostatically dyed metal accessories
- Practical folding away
- Ready to use in stylish single pack
- Plastic wedges which prevents slipping
- Exclusively designed steps which prevents slipping
- Decorative usage for both home and industrial use
- With safety lock
- Handle covered with polyurethane



SKY HOME OVAL MERDİVEN

PRACTICAL
METAL STEP
LADDER

BARKOD BARCODE	KOD CODE	BASAMAK SAYISI NUMBER OF STEPS	PROFİL PROFILE	1.KADEME YÜKSEKLİK FIRST STAGE HEIGHT	2.KADEME YÜKSEKLİK FIRST STAGE HEIGHT	PLATFORM YÜKSEKLİĞİ PLATFORM HEIGHT	ÇALIŞMA YÜKSEKLİĞİ WORKING HEIGHT	AMBALAJ (A,B,C) PACKING DIMENSION	AĞIRLIK WEIGHT
8682538141572	MHT E202	2	ø21x1,5	121	112	67	232	42X16X121	3,8
8682538141589	MHT E203	3	ø21x1,5	146	135	90	255	42X16X146	5,2
8682538141596	MHT E204	4	ø21x1,5	171	158	113	278	42X16X171	6,2



Zor koşulları kolaylaştırır.
Makes difficult conditions ease

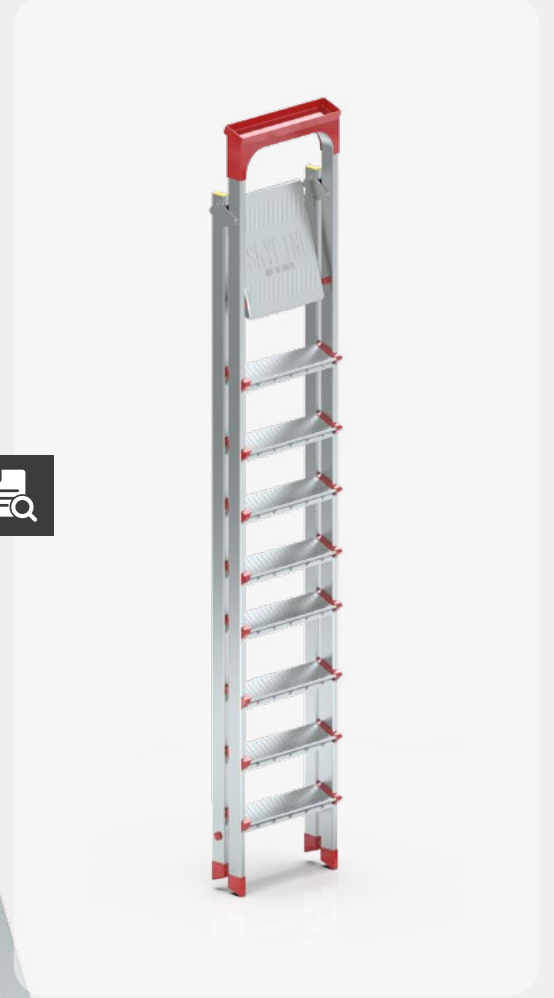

Detail / Detail



WWW.
mhtendustri
.com

Teknik Özellikler - Technical Specification

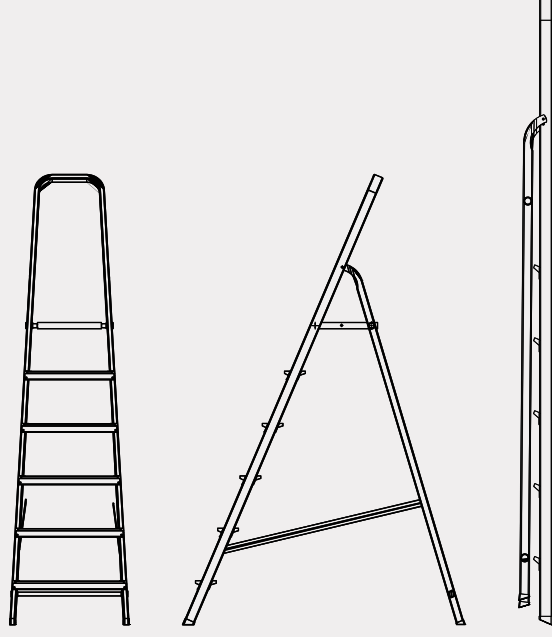

ÖZELLİKLER

- İlave tabla basamağı
- Özel alaşımli alüminyum merdiven
- Kolay açılıp kapanabilme
- Kullanıma hazır tek şıklı ambalaj
- Çizilmeyi önleyen plastik takozlar
- Kaymayı önleyen özel tasarımı basamaklar
- Ev ve işyerlerinde dekoratif kullanım
- Çok hafif ve yük taşımada kuvvetli
- Uzun ömürlü Paslanmaz maksimum mukavemet

SPECIFICATIONS

- Additional top step
- Special alloyed aluminum ladder
- Easy to fold away
- Ready to use stylish single pack
- Exclusively designed steps which prevents slipping
- Plastic wedges which prevents scuffing
- Decorative usage for both home and industrial use
- Very light weight and high resistance to heavy loading
- Durable, rustproof and maximum endurance



SKY LINE PROFİL MERDİVEN

PROFILE
LADDER

BARKOD BARCODE	KOD CODE	BASAMAK SAYISI NUMBER OF STEPS	PROFİL PROFILE	1.KADEME YÜKSEKLİK FIRST STAGE HEIGHT	2.KADEME YÜKSEKLİK FIRST STAGE HEIGHT	PLATFORM YÜKSEKLİĞİ PLATFORM HEIGHT	ÇALIŞMA YÜKSEKLİĞİ WORKING HEIGHT	AMBALAJ (A,B,C) PACKING DIMENSION	AĞIRLIK WEIGHT
8682538140018	MHT EP03	2+1	50X20	125	112	55	220	39x11x125	4,5
8682538140025	MHT EP04	3+1	50X20	138	128	83	248	41x11x138	5
8682538140032	MHT EP05	4+1	50X20	162	147	103	268	47x11x162	5,6
8682538140049	MHT EP06	5+1	50X20	186	170	126	291	50x11x186	6,6
8682538140056	MHT EP07	6+1	50X20	210	192	150	315	53x11x210	7,6
8682538140063	MHT EP08	7+1	50X20	235	222	178	343	56x11x235	8,5
8682538140070	MHT EP09	8+1	50X20	262	245	198	363	59x11x262	9,6
8682538140087	MHT EP10	9+1	50X20	282	262	218	383	62x11x282	10,5



Zor koşulları kolaylaştırır.
Makes difficult conditions ease



Detail / Detail



WWW.
mhtendustri
.com 

Teknik Özellikler - Technical Specification

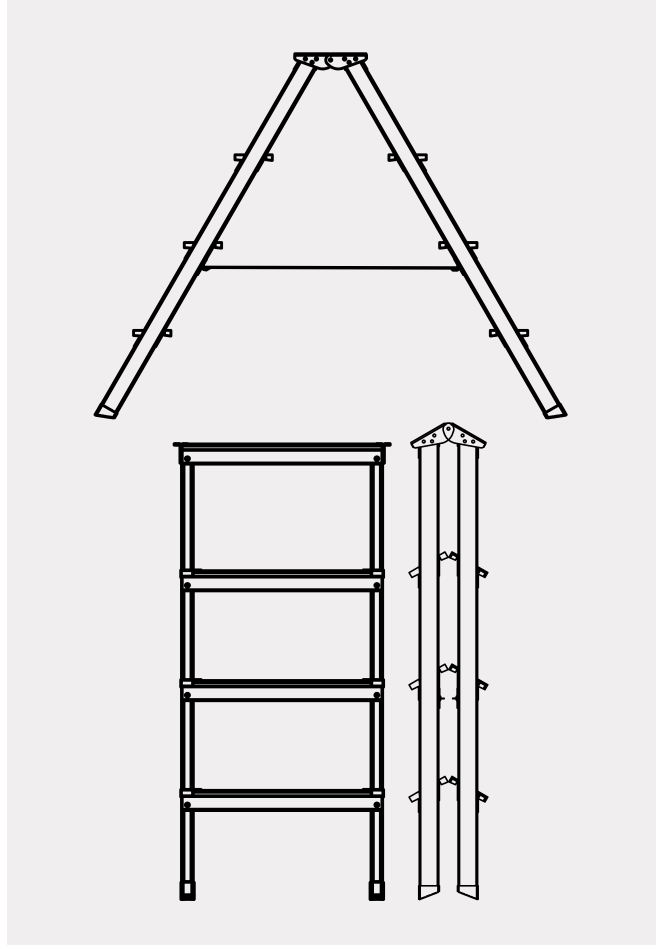

ÖZELLİKLER

- Özel alaşımli alüminyum merdiven
- Kolay açılıp kapanabilme
- Çift taraflı çıkış ve kullanabilme
- Kullanıma hazır tek şıklı ambalaj
- Çizilmeyi önleyen plastik takozlar
- Kaymayı önleyen özel tasarımı basamaklar
- Ev ve işyerlerinde dekoratif kullanım
- Çok hafif ve yük taşımada kuvvetli
- Uzun ömürlü Paslanmaz maksimum mukavemet

SPECIFICATIONS

- Special alloyed aluminum ladder
- Easy to fold away
- Easy to climb and use from both sides
- Ready to use stylish single pack
- Plastic wedges which prevents scuffing
- Exclusively designed steps which prevents slipping
- Decorative usage for both home and industrial use
- Very light weight and high resistance to heavy loading
- Durable, rustproof and maximum endurance



SKY LINE ÇİFT TARAFLI MERDİVEN

DOUBLE SIDED
METAL LADDER

BARKOD BARCODE	KOD CODE	BASAMAK SAYISI NUMBER OF STEPS	PROFİL PROFILE	1.KADEME YÜKSEKLİK FIRST STAGE HEIGHT	2.KADEME YÜKSEKLİK FIRST STAGE HEIGHT	ÇALIŞMA YÜKSEKLİĞİ WORKING HEIGHT	AMBALAJ (A,B,C) PACKING DIMENSION	AĞIRLIK WEIGHT
8682538140391	MHT M02	2+2	50X20	47	42	187	38X16X47	2,55
8682538140247	MHT M03	3+3	50X20	76	66	205	36X16X76	3,9
8682538140254	MHT M04	4+4	50X20	100	87	226	46X16X100	5,2
8682538140261	MHT M05	5+5	50X20	124	110	249	50X16X124	6,5
8682538140278	MHT M06	6+6	50X20	148	130	169	52X16X148	7,8
8682538140285	MHT M07	7+7	50X20	172	156	195	56X16X172	9,1
8682538140292	MHT M08	8+8	50X20	194	177	316	58X16X194	10,4
8682538140308	MHT M09	9+9	50X20	218	200	339	62X16X218	11,7
8682538141565	MHT M10	10+10	50X20	234	220	363	66X16X234	13



Zor koşulları kolaylaştırır.
Makes difficult conditions ease

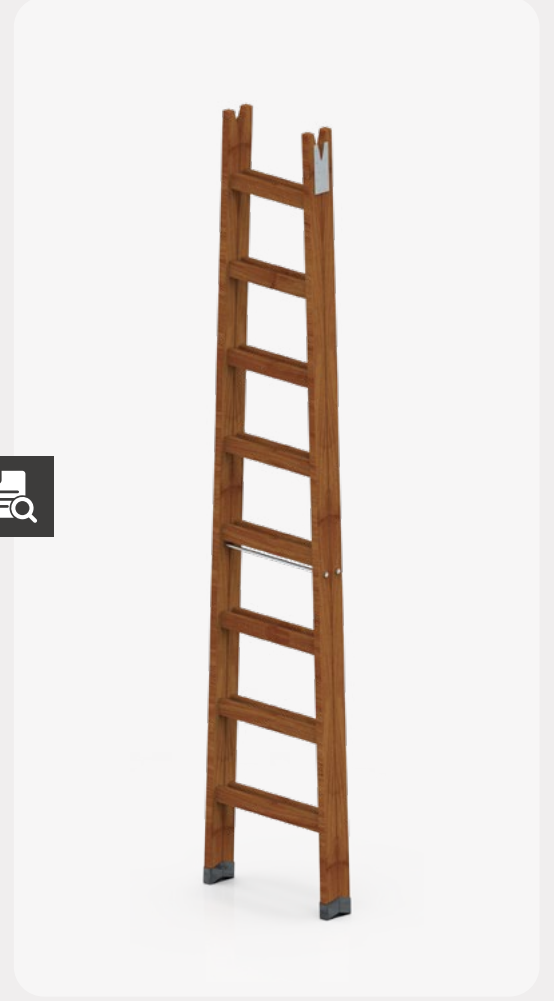

Detail / Detail



WWW.
mhtendustri
.com

Teknik Özellikler - Technical Specification

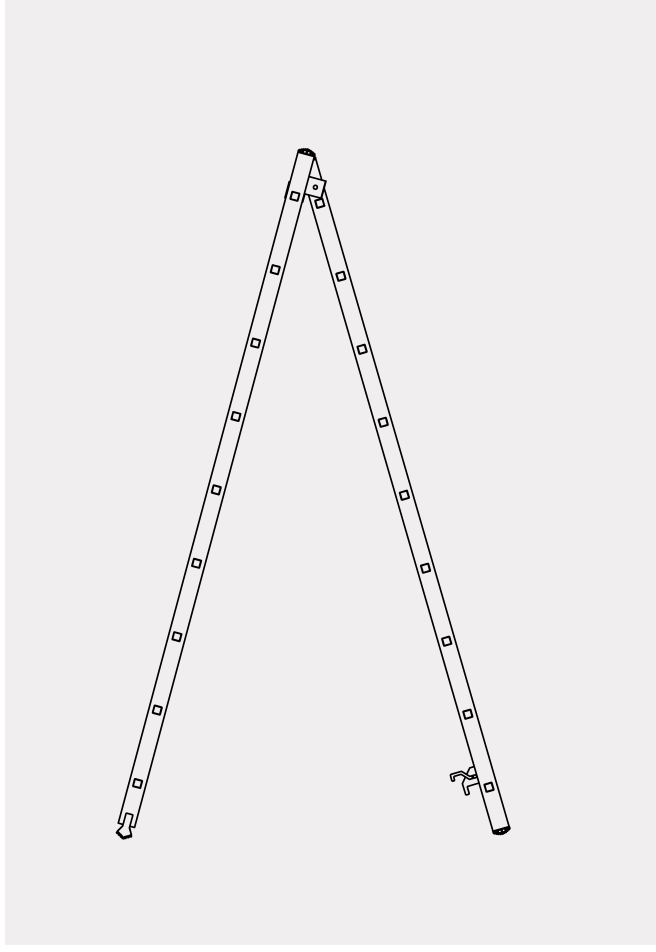

ÖZELLİKLER

- Özel alaşımli alüminyum merdiven
- Kolay açılıp kapanabilme
- Çift taraflı çıkış ve kullanabilme
- Kullanıma hazır tek şıklı ambalaj
- Çizilmeyi önleyen plastik takozlar
- Kaymayı önleyen özel tasarımı basamaklar
- Ev ve işyerlerinde dekoratif kullanım
- Çok hafif ve yük taşımada kuvvetli
- Uzun ömürlü Paslanmaz maksimum mukavemet

SPECIFICATIONS

- Special alloyed aluminum ladder
- Easy to fold away
- Easy to climb and use from both sides
- Ready to use stylish single pack
- Plastic wedges which prevents scuffing
- Exclusively designed steps which prevents slipping
- Decorative usage for both home and industrial use
- Very light weight and high resistance to heavy loading
- Durable, rustproof and maximum endurance



AHŞAP MERDİVEN

DOUBLE SIDED
METAL LADDER

BARKOD BARCODE	KOD CODE	BASAMAK SAYISI NUMBER OF STEPS	PROFİL PROFILE	1.KADEME YÜKSEKLİK FIRST STAGE HEIGHT	2.KADEME YÜKSEKLİK FIRST STAGE HEIGHT	ÇALIŞMA YÜKSEKLİĞİ WORKING HEIGHT
8682538140483	MHT AH03	3+3	110	100	265	35X10X106
8682538140490	MHT AH04	4+4	140	130	295	35X10X136
8682538140506	MHT AH05	5+5	170	158	323	35X10X166
8682538140513	MHT AH06	6+6	200	187	352	35X10X196
8682538140612	MHT AH07	7+7	230	221	386	35X10X226
8682538140629	MHT AH08	8+8	260	249	414	35X10X256
8682538140742	MHT AH09	9+9	290	280	445	35X10X286
8682538140964	MHT AH10	MEYVE TOPLAMA				
8682538140971	MHT AH11	AHŞAP SEHPA				



MHT ENDÜSTRİ METAL

MHT ENDÜSTRİ METAL SAN. TİC. LTD. ŞTİ.

Büsan Org. Sanayi Sitesi Fevzi Çakmak Mah
Milenyum Cad. No: 14 Karatay / KONYA

T: +90 332 502 21 24

info@mhtendustri.com - www.mhtendustri.com